



**HVNI**

**HIGH VOLTAGE, INC.**  
PRODUCT CATALOG





# HVI

**HIGH VOLTAGE, INC.**  
PRODUCT CATALOG

## **TABLE OF CONTENTS**

<b>VLV/VLF E Series</b>	<b>3</b>
<b>PFT Series</b>	<b>23</b>
<b>HPA Series</b>	<b>35</b>
<b>FPA Series</b>	<b>47</b>
<b>PAR Series</b>	<b>49</b>
<b>ALT Series</b>	<b>57</b>
<b>ABT Series</b>	<b>67</b>
<b>PTS Series</b>	<b>79</b>
<b>DBT Series</b>	<b>89</b>
<b>DTS Series</b>	<b>99</b>
<b>CDS Series</b>	<b>105</b>
<b>OCK Series</b>	<b>115</b>
<b>DVR Series</b>	<b>116</b>

# VLF SERIES CONTENTS

VLF AC Hipot Testers .....	4
VLF General Info .....	5
Features and Benefits .....	7
High Voltage Configurations .....	7
Controls and Configurations .....	7
VLF Series Specifications .....	9
Optional Accessories .....	22

# VLF E-SERIES CONTENTS

VLF E-Series .....	4
Features and Benefits .....	16
High Voltage Configurations .....	16
Controls and Configurations .....	17
VLF E-Link Software .....	17
VLF E-Series Specifications .....	18
VLF AC Withstand Testing of Cables .....	20
Optional Accessories .....	22

# VERY LOW FREQUENCY AC HIPOT TESTERS - DELIVERING SEAMLESS CABLE TESTING EFFICIENCY

HVI is the world's source for VLF hipot test sets with units in over 100 countries and proudly made in the USA. The High Voltage Inc. line of portable and affordable VLF hipots are designed to AC field test highly capacitive loads, particularly cables and rotating machinery. High Voltage Inc. offers a full line of VLF AC Hipots from 30 kVac to 200 kVac peak. Some models can test up to 50  $\mu\text{F}$  of load or approximately 50 miles of cable, and the largest of generators or motors. VLF is used for AC withstand testing and as a voltage source for Tan Delta and Partial Discharge Diagnostic Testing. HVI offers both its original, patented, long proven oil filled power supply models with analog controls and its all new solid state computer and microprocessor controlled design with wireless communication.

**SINCE 1998**, HVI has produced the most economical, rugged, and reliable VLF products available. Our electro-mechanical control and our oil filled HV power supply designs are extremely dependable, and easy to service in the field if necessary. The HVI design has a proven record with well over 2000 units in service worldwide.

**SINCE 2010**, HVI has produced the E-Series generation of VLF AC hipots using an air-cooled, solid state design with microprocessor control. High end features include user programmable test profiles/sequences, wireless communications to a user supplied PC, data retrieval and manual or automatic load based output frequency selection. The supplied E-Link PC software offers wireless remote operation, custom report generation, and test data export to .csv. Wireless communication between an E-Series VLF and the optional TD-65E Tan Delta Bridge, and/or user supplied PC is achieved via the XBee protocol which offers more reliability than Bluetooth.



CE

VLF-30CM(F)

## Very Low Frequency General Info

### What is VLF?

VLF stands for Very Low Frequency. HVI VLF products provide sinusoidal AC voltage but at 0.1 Hz - 0.01 Hz, compared to the 50/60 Hz output of conventional AC test sets. It is still an AC voltage with sinusoidal polarity reversals every half cycle. The VLF instrument is used to provide a simple pass/ fail withstand test. VLF instruments can be used as the voltage source for performing off-line Partial Discharge and Tan Delta cable diagnostic testing, both available from HVI.

### Why VLF?

VLF test sets are used to field test high capacitance loads such as cables and motors/generators. The lower the frequency of an AC source, the lower the current and power required to energize a capacitive load. At 0.1 Hz, it requires 600 times less power to test a cable than at 60 Hz. The HVI VLF instruments permit users to field test long cables and large generators with a portable and affordable test set. A 100 lb VLF instrument can do the job of a multi-ton 60 Hz AC test set. AC Cable testing can be done with HVI VLF products in a practical, economical, and easy to use package.

### When and Where Is VLF Used – Cable & Rotating Machinery

The principal use of VLF is testing medium and high voltage shield power cables. A long cable may have many microfarads of capacitance therefore, VLF technology is used to verify the insulation integrity of a cable. If the cable can't withstand 2-3 times normal voltage, it is not healthy and an in-service failure is likely. Defects in the cable insulation big enough to be excited by the VLF voltage applied will grow to failure during a Withstand Test. Find the fault, make the repair or replacement and be left with a healthier cable. Some of the world standards that define VLF testing are IEEE 400, 400.2, & 433, VDE 0276, CENELEC HD 620/621, SANA 10198, NEN 3620 and IEC 60502-2.

VLF is also very useful for testing large rotating machinery, since it provides a portable and affordable method of field-testing coils and is sanctioned by the IEEE 433-2009 standard.

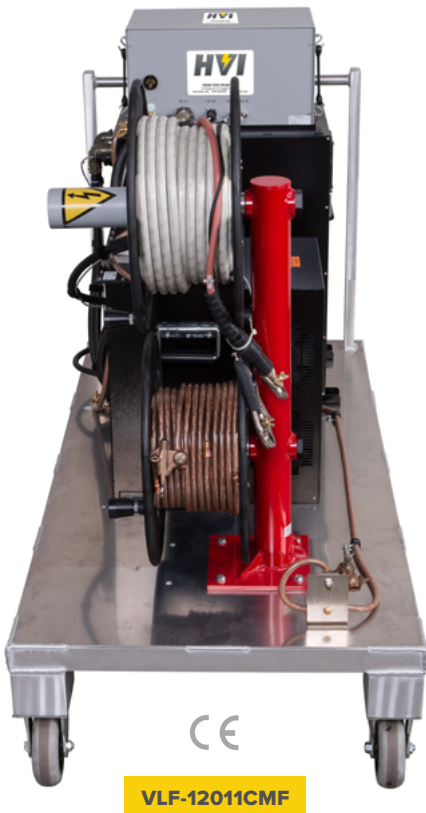

## Benefits of using HVI VLF AC Hipots

- Portable and affordable
- All models feature a true sinewave output
- Waveform is independent of load capacitance between 0.01  $\mu\text{F}$  and maximum load for VLF Series
- E-Series VLF units have no minimum load
- Highest load ratings available
- Highest voltage models available, 30 to 200kV peak
- Simple and easy operation
- AC testing does not degrade good cable insulation
- Harmful space charges are not injected into the cable insulation
- No traveling waves are generated
- BNC scope output for waveform viewing
- Rugged and reliable designs less prone to failure from transients

## Two Design Choices

Original patented, electro-mechanical, transformer designs and the latest solid-state microprocessor-controlled designs, both are available from HVI.

## Rugged Oil Filled HV Sections with Electro-mechanical Controls

The HVI VLF design offers the best of everything, with manual, easy to use controls but also sophisticated data collection. Electric utilities and industrials have long recognized the benefit of our technology. HVI knows how to build long lasting field test equipment. Models range from 30kV peak to 200kV peak. HVI also manufactures specialty models with very high load rating for testing extremely long lengths of cables commonly found in windfarm, solar, or subsea applications.

HVI also offers the latest in solid state design VLF units that offer many benefits, like automatic programmable controls, wireless communication and report generation. See our VLF E-Series for more details.

## Original Patented Transformer Based Design\*

- |                |  |
|----------------|--|
| • VLF-30CM     | 0-30 kVac, 0.1 Hz, load rated to 0.4 $\mu\text{F}$             |
| • VLF-4022CM   | 0-44 kVac, 0.1 Hz - 0.02 Hz, load rated to 5.5 $\mu\text{F}$   |
| • VLF-50CMF    | 0-50 kVac, 0.1 Hz - 0.01 Hz, load rated to 50 $\mu\text{F}$    |
| • VLF-6022CM   | 0-62 kVac, 0.1 Hz - 0.02 Hz, load rated to 5.5 $\mu\text{F}$   |
| • VLF-65CMF    | 0-65 kVac, 0.1 Hz - 0.01 Hz, load rated to 22 $\mu\text{F}$    |
| • VLF-90CMF    | 0-90 kVac, 0.1 Hz - 0.02 Hz, load rated to 2.75 $\mu\text{F}$  |
| • VLF-12011CMF | 0-120 kVac, 0.1 Hz - 0.01 Hz, load rated to 5.5 $\mu\text{F}$  |
| • VLF-140CMF   | 0-140 kVac, 0.1 Hz - 0.02Hz, load rated to 7.5 $\mu\text{F}$   |
| • VLF-200CMF   | 0-200 kVac, 0.1 Hz - 0.02 Hz, load rated to 3.75 $\mu\text{F}$ |

**\*values are peak voltage**

## Features and Benefits

- Sine wave output at 0.1, 0.05 and 0.02 Hz frequencies standard. Some offered with 0.01Hz
- Continuously adjustable output voltage
- Continuous duty rating
- Fixed thermal circuit breaker overload
- “Zero Start” and External Interlock provision
- Single-range voltmeter
- Single -range Current/Capacitance meter
- VLF-30CM comes as single-piece design
- VLF-4022CM, VLF-6022CM, VLF-90CMF come as Two-piece portable design
- VLF-50CMF, VLF-65CMF, and VLF-120CMF come on 4 wheel push cart
- Transit protected meters prevents damage between test sites
- Ground stick provided for increased operator safety. Can be used to safely connect the unit and the test load to ground before and after test

## High Voltage Section Configurations



### Cable Output

Shielded output cables are standard on models rated 120kV peak and below.

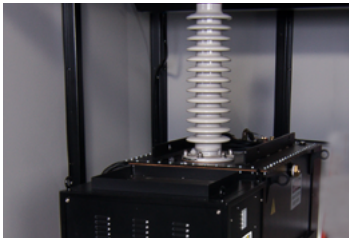

### Bushing Output

Toroidal dish on oil filled porcelain bushing.

## Controls and Configuration

### VLF-30CM

- Sine wave output at 0.1Hz
- Continuously adjustable output voltage
- Fixed thermal circuit breaker overload
- Single-range center “0” voltmeter
- Single -range Current meter
- Transit protected meters prevents damage between test sites
- Zero start safety interlock
- External interlock provisions

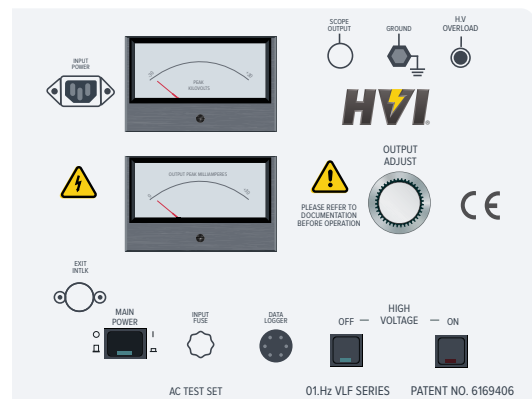

## VLF-4022CM

- Sine wave output at 0.1Hz, 0.05Hz, and 0.02Hz
- Continuously adjustable output voltage
- Fixed thermal circuit breaker overload
- Single-range center “0” voltmeter
- Single-range Current/Capacitance meter
- Transit protected meters prevents damage between test sites
- Zero start safety interlock
- External interlock provisions

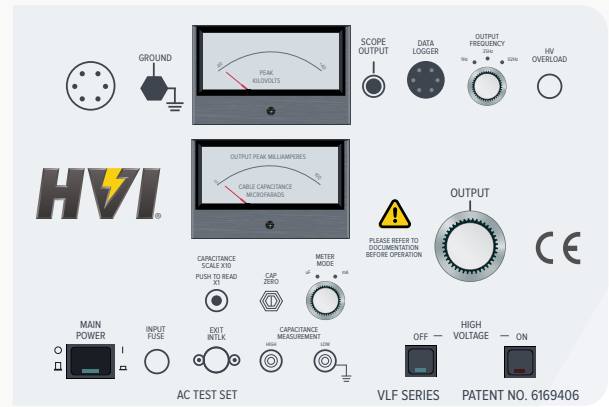

## VLF-50CMF, VLF-65CMF, and VLF-12011CMF

- Sine wave output at 0.1Hz, 0.05Hz, 0.02Hz, and 0.01Hz
- Continuously adjustable output voltage
- Fixed thermal circuit breaker overload
- Single-range voltmeter with polarity indication
- Single-range Current/Capacitance meter
- Transit protected meters prevents damage between test sites
- Built in test duration timer with alarm
- Zero start safety interlock
- External interlock provisions

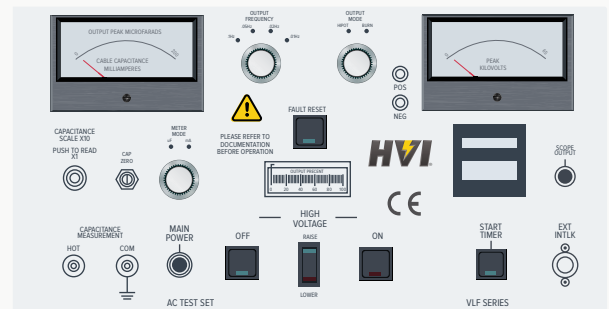

## VLF-6022CM and VLF-90CMF

- Sine wave output at 0.1Hz, 0.05Hz, and 0.02Hz
- Continuously adjustable output voltage
- Fixed thermal circuit breaker overload
- Single-range voltmeter with polarity indication
- Single-range Current/Capacitance meter
- Transit protected meters prevents damage between test sites
- Built in test duration timer with alarm
- Zero start safety interlock
- External interlock provisions

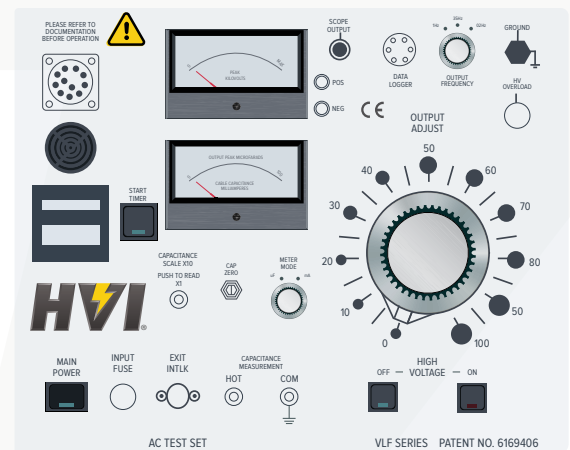



## VLF-140CMF and VLF-200CMF

- Sine wave output at 0.1Hz, 0.05Hz, and 0.02Hz
- Continuously adjustable output voltage
- Fixed thermal circuit breaker overload
- Single-range voltmeter with polarity indication
- Single -range Current/Capacitance meter
- Transit protected meters prevents damage between test sites
- Built in test duration timer with alarm
- Built in ADL-1 Automatic Data Logger for Voltage and Current vs Time test data
- Zero start safety interlock
- External interlock provisions

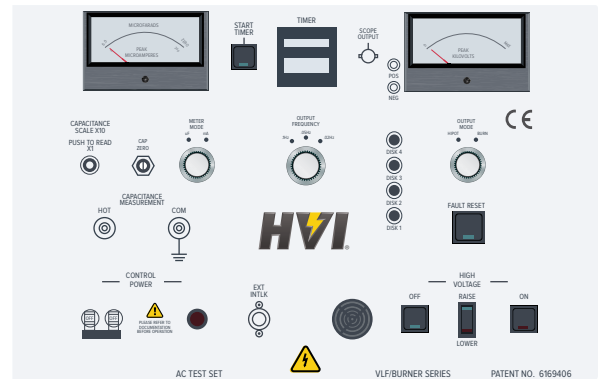

## VLF Series Specifications

All HVI VLF designs produce a sine wave output that meets the requirements of world standards, permitting it to be used as a voltage source for Tan Delta and Partial Discharge diagnostic testing.

All HVI equipment is built and serviced in the USA at HVI. All products and parts are kept in stock and quick turnaround is guaranteed.





## VLF Series Specifications



VLF-30CM



VLF-4022CM

### VLF-30CM

**Input:** 120 Vac, 7A, 50/60 Hz (VLF-30CM)  
230 Vac, 3A, 50/60 Hz (VLF-30CMF)

**Output:** Sinusoidal 0 - 30 kVac peak, 0.1Hz frequency

**Duty:** Continuous

**Max Test Capacitance:** 0.4 $\mu$ F @ 0.1 Hz  
Minimum capacitance to achieve full output- .005 $\mu$ F

**Voltmeter:** 3.5 in. Analog, Center Zero,  
-30 - 0 - +30 kV peak, +/- 2% Accuracy

**Current Meter:** 3.5 inch Analog, 0 - 50mA peak,  
+/- 2% Accuracy

**Size & Weight:** 14.25 x 11.25 x 21.75in., 85lb.  
362 x 286 x 552mm, 39kg

**Output Termination:** 20ft. RG8U shielded XLPE cable  
with Alligator Clamp

**Scope of Supply:** 20ft. black test lead, safety ground stick, external  
interlock plug, operations manual, calibration certificate

### VLF-4022CM

120 Vac, 10A, 50/60 Hz (VLF-4022CM)  
230 Vac, 6A, 50/60 Hz (VLF-4022CMF)

Sinusoidal 0 - 44 kVac peak, 0.1, 0.05,  
and 0.02 Hz frequency

Continuous

1.1 $\mu$ F @ 0.1 Hz, 2.2 $\mu$ F @ 0.05 Hz, 5.5 $\mu$ F  
@ 0.02 Hz  
Minimum capacitance to achieve full  
output- .01 $\mu$ F

3.5 in. Analog, Center Zero,  
-45 - 0 - +45 kV peak, 2% Full-scale Accuracy

3.5 inch Analog, 0 - 100mA peak, 5 - 0  $\mu$ F, +/- 5%  
Accuracy

**Control:** 22 x 11.25 x 15 in., 50 lb.  
559 x 286 x 387 mm, 23 kg  
**HV Section:** 14.5 x 10.5 x 19 in., 72 lb.  
368 x 267 x 483 mm, 33 kg

20ft. RG8U shielded XLPE cable  
with Alligator Clamp

Accessory bag, 10ft. interconnect cable, 20ft. green/  
yellow ground lead, 20ft. red test lead, 20ft. black  
test lead, safety ground stick, external interlock plug,  
operations manual, calibration certificate

## VLF Series Specifications



VLF-50CMF



VLF-6022CM

### VLF-50CMF

**Input:** 230Vac +/- 10%, 30A peak, 25A avg, 50/60Hz  
Sinusoidal power required for full output

**Output:** Sinusoidal 0 - 50 kVac peak, 0.1, 0.05,  
0.02 and 0.01 Hz frequency

**Duty:** Continuous

**Max Test Capacitance:** 5.0 $\mu$ F @ 0.1 Hz, 10.0 $\mu$ F @ 0.05 Hz, 25.0 $\mu$ F @ 0.02 Hz, 50.0 $\mu$ F @ 0.01 Hz  
Minimum capacitance to achieve full output- .01 $\mu$ F

**Voltmeter:** 3.5 in. Analog, 0 - 60 kV peak,  
2% Full-scale Accuracy

**Current Meter:** 3.5 inch Analog, 0 - 200mA peak, 6 - 0 uF, +/- 5%  
Accoracy

**Size & Weight:** Complete Trolley: 28 x 60 x 51in., 775lb.  
711 x 1524 x 1295mm, 352kg

**Output Termination:** 100ft. shielded EPR cable on reel with MC  
connector and vicegrip adapter

**Scope of Supply:** 4 wheel trolley, interconnect cables, 100ft. ground lead  
on reel, 20ft. red test lead, 20ft. black test lead, safety  
ground stick, external interlock plug, operations manual,  
calibration certificate

### VLF-6022CM

120 Vac, 15A, 50/60 Hz (VLF-6022CM)  
230 Vac, 8A, 50/60 Hz (VLF-6022CMF)

Sinusoidal 0 - 62 kVac peak, 0.1, 0.05,  
and 0.02 Hz frequency

Continuous

1.1 $\mu$ F @ 0.1 Hz, 2.2 $\mu$ F @ 0.05 Hz, 5.5 $\mu$ F @ 0.02 Hz  
Minimum capacitance to achieve full  
output- .01 $\mu$ F

3.5 in. Analog, 0 - 65 kV peak,  
2% Full-scale Accuracy

3.5 inch Analog, 0 - 100mA peak, 5 - 0 uF, +/- 5%  
Accoracy

**Control:** 26 x 13 x 16 in., 75 lb.  
660 x 330 x 406 mm, 34 kg  
**HV Section:** 15 x 11 x 21.5 in., 120 lb.  
381 x 280 x 546 mm, 54 kg

20ft. shielded EPR cable with Alligator Clamps

10ft. interconnect cables, 20ft. green/yellow ground  
lead, 20ft. red test lead, 20ft. black test lead, safety  
ground stick, external interlock plug, operations manual,  
calibration certificate



VLF-65CMF



VLF-90CMF

## VLF-65CMF

**Input:** 230Vac +/- 10%, 30A peak, 20A avg, 50/60Hz  
Sinusoidal power required for full output

**Output:** Sinusoidal 0 - 65 kVac peak, 0.1, 0.05, 0.02 and 0.01 Hz frequency

**Duty:** Continuous

**Max Test Capacitance:** 2.2 $\mu$ F @ 0.1 Hz, 4.4 $\mu$ F @ 0.05 Hz, 11 $\mu$ F @ 0.02 Hz, 22 $\mu$ F @ 0.01 Hz  
Minimum capacitance to achieve full output- .01 $\mu$ F

**Voltmeter:** 3.5 in. Analog, 0 - 75 kV peak, 2% Full-scale Accuracy

**Current Meter:** 3.5 inch Analog, 0 - 200mA peak, 6 - 0  $\mu$ F, +/- 5% Accuracy

**Size & Weight:** Complete Trolley: 28 x 60 x 51in., 680lb.  
762 x 1524 x 1295mm, 309kg

**Output Termination:** 100ft. shielded EPR cable on reel with MC connector and vicegrip adapter

**Scope of Supply:** 4 wheel trolley, 10ft. interconnect cables, 100ft. ground lead on reel, 20ft. red test lead, 20ft. black test lead, safety ground stick, external interlock plug, operations manual, calibration certificate

## VLF-90CMF

230Vac +/- 10%, 15A peak, 50/60Hz  
Sinusoidal power required for full output

Sinusoidal 0 - 90 kVac peak, 0.1, 0.05, and 0.02 Hz frequency

Continuous

0.55 $\mu$ F @ 0.1 Hz, 1.1 $\mu$ F @ 0.05 Hz, 2.75 $\mu$ F @ 0.02 Hz  
Minimum capacitance to achieve full output- .01 $\mu$ F

3.5 in. Analog, 0 - 100 kV peak, 2% Full-scale Accuracy

3.5 inch Analog, 0 - 100mA peak, 5 - 0  $\mu$ F, +/- 5% Accuracy

**Control:** 26 x 13 x 16in., 75lb.  
660 x 330 x 406 mm, 34 kg  
**HV Tank:** 15 x 21 x 29 in., 293 lb.  
381 x 533 x 686 mm, 133 kg

20ft. shielded EPR cable with Alligator Clamps

10ft. interconnect cables, 20ft. green/yellow ground lead, 20ft. red test lead, 20ft. black test lead, safety ground stick, external interlock plug, operations manual, calibration. Optional Handcart HC-VLF90 shown above.

## VLF Series Specifications



VLF-1201CMF



VLF-140CMF

### VLF-1201CMF

**Input:** 230Vac +/- 10%, 30A peak, 50/60Hz  
Sinusoidal power required for full output

**Output:** Sinusoidal 0 - 120 kVac peak, 0.1, 0.05, 0.02 and 0.01 Hz frequency

**Duty:** Continuous

**Max Test Capacitance:** 0.55 $\mu$ F @ 0.1 Hz, 1.1 $\mu$ F @ 0.05 Hz, 2.2 $\mu$ F @ 0.02 Hz, 5.5 $\mu$ F @ 0.01 Hz  
Minimum capacitance to achieve full output- .01 $\mu$

**Voltmeter:** 3.5 in. Analog, 0 - 120 kV peak, 2% Full-scale Accuracy

**Current Meter:** 3.5 inch Analog, 0 - 100mA peak, 5 - 0  $\mu$ F, +/- 5% Accuracy

**Size & Weight:** Complete Trolley: 30 x 60 x 51in., 853lb.  
762 x 1524 x 1295mm, 388kg

**Output Termination:** 100ft, shielded EPR cable on reel. External limit resistor and alligator clamp.

**Scope of Supply:** 4 wheel trolley, interconnect cables, 100ft. ground lead on reel, 20ft. red test lead, 20ft. black test lead, safety ground stick, external interlock plug, operations manual, calibration certificate

### VLF-140CMF

230Vac, 80A peak, 50/60Hz  
Sinusoidal power required for full output

Sinusoidal 0 - 140 kVac peak, 0.1, 0.05, 0.02 Hz frequency

Continuous

1.5 $\mu$ F @ 0.1 Hz, 3 $\mu$ F @ 0.05 Hz, 7.5 $\mu$ F @ 0.02 Hz  
Minimum capacitance to achieve full output- 0.005 $\mu$ F

3.5 in. Analog, 0 - 150 kV peak, 2% Full-scale Accuracy

3.5 inch Analog, 0 - 200mA peak, 5 - 0  $\mu$ F, +/- 5% Accuracy

**Control:** 23 x 30 x 62 in., 750 lb.  
584 x 762 x 1575 mm, 340 kg  
**HV Tank:** 61 x 37 x 61 in., 2555 lb.  
1550 x 940 x 1550 mm, 1160 kg

Oil Filled Porcelain Apparatus Bushing, 250kV BIL Rating

Interconnect cables, 100ft ground lead on reel, data logger built in, 20ft. red test lead, 20ft. black test lead, safety ground stick, external interlock plug, operations manual, calibration certificate



VLF-200CMF

## VLF-200CMF

**Input:** 230Vac, 80A peak, 50/60Hz  
Sinusoidal power required for full output

**Output:** Sinusoidal 0 - 200 kVac peak, 0.1, 0.05, 0.02 Hz frequency

**Duty:** Continuous

**Max Test Capacitance:** 0.75 $\mu$ F @ 0.1 Hz, 1.5 $\mu$ F @ 0.05 Hz, 3.75 $\mu$ F @ 0.02 Hz  
Minimum capacitance to achieve full output- 0.005 $\mu$ F

**Voltmeter:** 3.5 in. Analog, 0 - 200 kV peak, 2% Full-scale Accuracy

**Current Meter:** 3.5 inch Analog, 0 - 200mA peak, 5 - 0 uF, +/- 5% Accuracy

**Size & Weight:** Control: 23 x 30 x 62in., 750lb.  
584 x 762 x 1575 mm, 340 kg  
HV Tank: 59 x 37 x 87 in., 3300 lb.  
1500 x 940 x 2210 mm, 1497 kg

**Output Termination:** Oil Filled Porcelain Apparatus Bushing,  
350kV BIL Rating

**Scope of Supply:** Interconnect cables, 100ft ground lead on reel, data logger built in, 20ft. red test lead, 20ft. black test lead, safety ground stick, external interlock plug, operations manual, calibration certificate

# VLF E-SERIES MODERN SOLID-STATE VLF HIPOTS WITH MICROPROCESSOR CONTROL AND WIRELESS COMMUNICATION CAPABILITY

The E-Series VLF Test Sets from HVI are the newest generation of VLF hipots that use a dry-type, air cooled, solid-state design with microprocessor control. Better design equals better results!

The test programming, numerous output functions, wireless communications, and data retrieval are intuitive and easy to learn. They are lightweight, portable, affordable, and built for the rigors of field use, like all HVI products. The use of the XBee protocol over Bluetooth has the benefit of stronger signal connection allowing a longer communication distance, less signal interference from other common wireless devices, and works in more signal-sensitive areas which translates to less dropped connections while testing. Models range from 34 kVac peak to 65kV peak meeting world standards for Acceptance Testing up to 35 kV class cable. Its sine wave output is suitable for using optional Tan Delta or Partial Discharge measurement systems, like the HVI TD-65E Tan Delta System. HVI E-Series VLF and accessories are everything needed to perform diagnostic and withstand testing of cables rated to 35kV.

## Solid State with Microprocessor Controls



### VLF-34E

0-34 kVac, 0.1 Hz - 0.01 Hz, load rated to 5.0  $\mu$ F



### VLF-65E

0-65 kVac, 0.1 Hz - 0.01 Hz load rated to 10.0  $\mu$ F

## Features and Benefits

- Multiple output modes:
  - Sine wave – 0.1Hz to 0.01Hz, 0 – max voltage
  - Square wave - 0.1Hz to 0.01Hz, 0 – max voltage
  - DC + or - to max voltage
- Output Frequency, 0.1Hz to 0.01Hz in 0.01Hz increments
- Voltage metering can be set to meter in kV peak or kV RMS
- Current metering can be set to meter in mA peak or mA RMS
- Calculates Capacitance, Resistance, Flashover voltage, Time to Failure
- 20' Shielded output cables and test leads
- Test results saved in internal memory
- No Bluetooth, the XBee protocol offers a more robust and reliable wireless connection
- Upload data to PC via USB Flash Drive or wirelessly via the XBee Protocol
- E-Link software included! Allows for:
  - Remote control of the VLF wirelessly via the XBee Protocol
  - Creation of custom test reports
  - Creation of custom test profiles and test sequences
  - Export results to .csv file
- PC Not required for testing, even while using the TD-65E Tan Delta accessory

## High Voltage Section Configurations



### Cable Output

Shielded output cables are standard on models rated 65kV peak and below.

## Controls and Configuration

VLF-34E and VLF-65E

- Large LCD with easy menu driven interface
- Large rotary encoder for easy menu navigation even while wearing gloves
- LCD shows wave form, voltage, current, capacitance (where applicable), and resistance (where applicable)
- Run a manually programmed test or choose from a previously programmed test profile
- USB port for data upload via USB flash drive
- PC Not required for testing, even while using the TD-65E Tan Delta accessory
- Same controls and E-Link software used on all VLF E-Series models

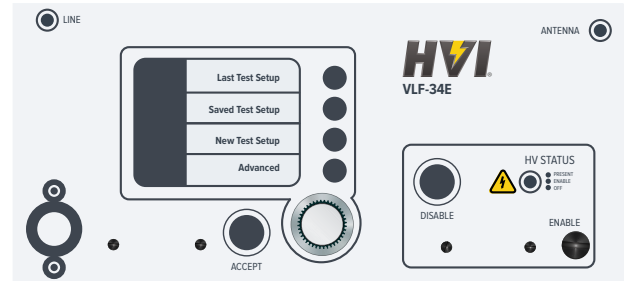

## VLF E-Series E-Link Software

### High End Remote Control and report generation software

HVI customers are providing a lot of positive feedback about E-Link, the new software that makes local and remote control of HVI's VLF and TD cable test system easier than ever before.

#### Local Mode

The local mode of operation logs test data to the internal memory of the VLF unit or to a removable USB flash drive. The logged data can be transferred from the VLF unit to the included PC application software for evaluation and reporting with a USB drive or an XBee wireless connection.

#### Remote Mode

The remote mode of operation uses a laptop PC to wirelessly connect to the E-Series VLF. Once connected, the E-Link PC software application allows the user to input or change the test parameters, view the live test data, save the logged data directly to the PC, and upload custom test profiles or sequences of test profiles.

#### Report Generation

E-Link's menu-driven reports feature allows the user to quickly generate custom test reports that include header information input by the user, company logos, and graphs/tables of the logged data. E-Link can also export data in .csv or a Microsoft Access compatible format for more detailed reporting or database input.



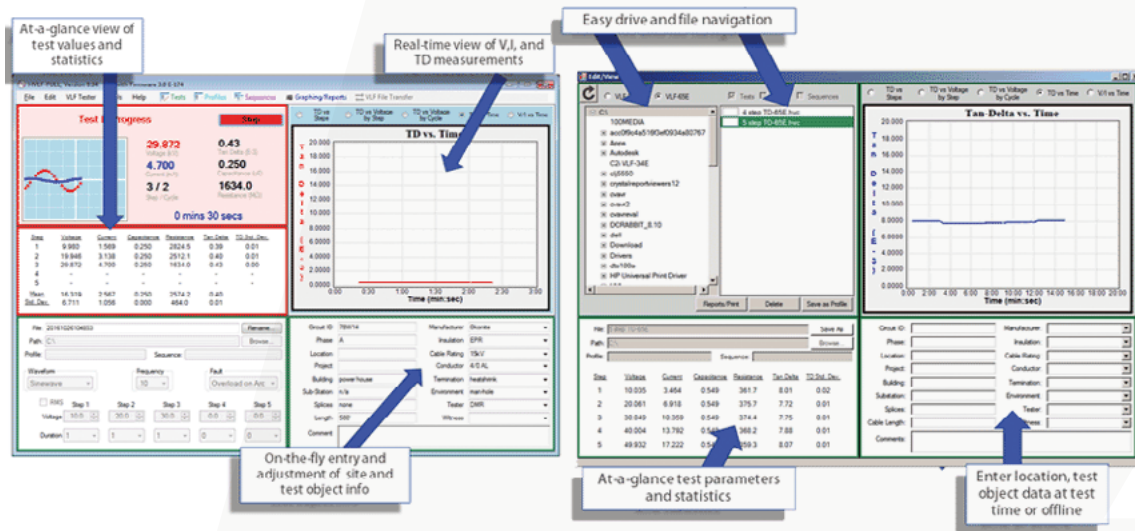

## Features and Benefits

- Easy installation—just run the setup program
- Local and remote operation
- Easy test setup via the VLF front panel or PC software
- Programmable test profiles
- XBee wireless—higher connection sustainability, longer range for remote VLF and TD testing
- Advanced data capture capabilities
- Intuitive VLF and TD report templates
- E-Link software and firmware comes standard with all E-Series VLF Test Sets
- TD average and standard deviation continuously updated for easy evaluation
- PC not required for withstand or TD testing
- Data stored automatically in VLF memory with optional backups to USB and PC

## VLF E-Series Specifications

All HVI VLF designs produce a sine wave output that meets the requirements of world standards, permitting it to be used as a voltage source for Tan Delta and Partial Discharge diagnostic testing.

All HVI equipment is built and serviced in the USA. All products and parts are kept in stock and quick turnaround is guaranteed.

## VLF E-Series Specifications



VLF-34E



VLF-65E

### VLF-34E

### VLF-65E

**Input:** 100 - 265Vac, 50/60Hz, 5A max

100 - 265Vac, 50/60Hz, 20A max

**Output:** VLF Sinewave: 0 - 34kVPeak (24kVrms), resolution:  $\pm 0.1$ kV  
 VLF Square wave: 0 - 34kVPeak, resolution:  $\pm 0.1$ kV  
 DC:  $\pm 0$  - 34kV (Proof Test, Sheath Test), resolution:  $\pm 0.1$ kV

VLF Sinewave: 0 - 65kVPeak (46kVrms), resolution:  $\pm 0.1$ kV  
 VLF Square wave: 0 - 65kVPeak, resolution:  $\pm 0.1$ kV  
 DC:  $\pm 0$  - 65kV (Proof Test, Sheath Test), resolution:  $\pm 0.1$ kV

**Duty:** Continuous

Continuous

**Load Rating:** 0.5 $\mu$ F@0.1Hz@34kVp, 5.0 $\mu$ F@0.01Hz@34kVp, calculated  
 1.7kVp\* $\mu$ F\*Hz  $\mu$ F rating increases at lower voltages, Ex:  
 0.77 $\mu$ F@0.1Hz@22kVp

1.0 $\mu$ F@0.1Hz@ 65kVp, 10.0 $\mu$ F@0.01Hz@ 65kVp,  
 calculated 6.5kVp\* $\mu$ F\*Hz  $\mu$ F rating increases at lower  
 voltages, Ex: 1.4 $\mu$ F@ 0.1Hz@ 47kVp

**Frequency:** 0.01 to 0.1Hz in 0.01Hz Increments, auto-frequency detect

0.01 to 0.1Hz in 0.01Hz Increments, auto-frequency detect

**Metering:** 5.7" Color LCD display  
 Voltage (kVp/kVrms):  $\pm 1\%$  accuracy, 0.001kV resolution  
 Current (mA<sub>p</sub>/mA<sub>rms</sub>):  $\pm 1\%$  accuracy, 0.001mA resolution  
 Calculated: Capacitance, Resistance, Flashover Voltage,  
 and Time to Failure

5.7" Color LCD display  
 Voltage (kVp/kVrms):  $\pm 1\%$  accuracy, 0.001kV resolution  
 Current (mA<sub>p</sub>/mA<sub>rms</sub>):  $\pm 1\%$  accuracy, 0.001mA resolution  
 Calculated: Capacitance, Resistance, Flashover Voltage,  
 and Time to Failure

**Fault Response:** Fault on Arc and Burn on Arc

Fault on Arc and Burn on Arc

**Memory:** Internal: 50 test records  
 External (USB Drive): Limited by media capacity

Internal: 50 test records  
 External (USB Drive): Limited by media capacity

**PC Interface:** External USB (Firmware Upgrade Only)  
 XBee 802.15.4 (wireless, ~30ft range)

External USB (Firmware Upgrade Only)  
 XBee 802.15.4 (wireless, ~30ft range)

**PC Software:** E-Link remote control and report generation software  
 included

E-Link remote control and report generation software  
 included

**Size and Weight:** 19.7 x 12 x 18in., 45lb.  
 500 x 305 x 457mm, 21kg

22 x 15.5 x 26in., 150lb.  
 559 x 394 x 660mm, 68kg

**Output Termination:** 20ft. RG8U shielded XLPE cable with Alligator Clamp

20ft. shielded EPR cable with Alligator Clamp

**Scope of Supply:** Accessory bag, 20ft. ground lead, safety ground stick, external interlock plug, mainpower key, XBee USB antenna, USB flash drive with E-Link software and electronic operations manual, paper operations manual, calibration certificate

# VLF AC Withstand Testing of Cables

## Testing Methodology

When VLF Withstand testing cable, the proper test voltage and time duration are critical for the success of the test. A defect that is big enough to be excited by the applied voltage will grow to failure during the test. Lesser defects are not affected. They remain dormant and are not aggravated by the test voltage. The information and data that follows is taken directly from the IEEE 400.2-2023 Standard.

## IEEE Std. 400.2-2023

IEEE Guide for Field Testing of Shielded Power Cable Systems Using Very Low Frequency (VLF) (less than 1 Hz)

**Table 3 - VLF withstand test voltages for sinusoidal and cosine-rectangular waveforms (see note 1)**

WAVEFORM	Cable system rating (phase to phase) [kV]	Installation (phase to ground)		Acceptance (phase to ground)		Maintenance2 (phase to ground) (see Note 2)	
		[kV RMS]	[kV PEAK]	[kV RMS]	[kV PEAK]	[kV RMS]	[kV PEAK]
Sinusoidal	5	9	13	10	14	7	10
	8	11	16	13	18	10	14
	15	19	27	21	30	16	22
	20	24 (Note 3)	34 (Note 3)	26	37	20	28
	25	29 (Note 3)	41 (Note 3)	32	45	24 (Note 3)	34 (Note 3)
	28	32	45	36 (Note 3)	51 (Note 3)	27	38
	30	34	48	38	54	29 (Note 3)	41
	35	39	55	44	62	33	47
	46	51	72	57	81	43	61
	69	75	106	84	119	63	89
	115	125	176	140	198	105	148
	138	150	212	168	238	126	178

VLF ac voltage testing methods utilize ac signals at frequencies in the range of 0.01 Hz to 1 Hz. The most commonly used, commercially available VLF ac voltage test frequency is 0.1 Hz. VLF ac test voltages with cosine- rectangular and the sinusoidal wave shapes are most commonly used. While other wave shapes are available for testing of cable systems, recommended test voltage levels have not been established.

**NOTE 1** If the operating voltage is a voltage class lower than the rated voltage of the cable, it is recommended that the maintenance test voltages should be those corresponding to the operating voltage class.

**NOTE 2** The maintenance voltage is about 75% of the acceptance test voltage magnitude.

**NOTE 3** Some existing test sets have a maximum voltage that is up to 5% below the values listed in the table. These test sets are acceptable to be used. However, there is a risk that the cable may be “undertested” due to a combination of lower test voltage and allowed uncertainty of the measuring circuit.

## 5.1 General VLF ac Withstand Voltage Testing

### 5.1.1 VLF ac withstand voltage test parameters

The purpose of a withstand test is to verify the integrity of the cable under test. If the cable under test has a defect big enough to be excited by the voltage applied, an electrical tree will initiate and grow through the insulation.

## 5.1 General VLF ac Withstand Voltage Testing (cont.)

Inception of an electrical tree and channel growth time are functions of several factors including test voltage, source frequency and amplitude, and the geometry of the defect. For an electrical tree from the tip of a needle in PE insulation in laboratory conditions to completely penetrate the insulation during the test duration, VLF ac voltage test levels and testing time durations have been established for the two most commonly used test voltage sources, the cosine-rectangular and the sinusoidal wave shapes. However, the time to failure will vary according to the type of insulation such as PE, paper, and rubber. Thus the electrical tree growth rate is not the same for all materials and defects.

The voltage levels (installation and acceptance) are based on the most used, worldwide practices of from 2 U<sub>0</sub> to 3U<sub>0</sub>, where U<sub>0</sub> is the rated rms phase to ground voltage, for cables rated between 5 kV and 69 kV. The maintenance test level is about 75% of the acceptance test level.

One can reduce the test voltage by another 20% if the voltage is applied for longer times (Bach [B2]; Baur, Mohaupt, and Schlick, [B6]; Krefter [B27]). Evidence (Hernandez-Mejía, et al. [B21]) indicates that increasing the voltage above 3U<sub>0</sub> to compensate for reduced test cycles (time) does not replicate performance either on test or in service as compared to the lower voltage, longer time tests.

Table 3 lists voltage levels for VLF withstand testing of shielded power cable systems using cosine-rectangular and sinusoidal waveforms (Bach [B2]; Eager, et al. [B9]; Krefter [B27]; Moh [B28]). For a sinusoidal waveform the rms is 0.707 of the peak value, assuming the harmonic distortion is less than 5%. The rms and peak values of the cosine-rectangular waveform are assumed to be equal.

It should be noted that terminations may need to be added to avoid flashover for installation tests on cables rated above 35 kV.

### Regarding the test times:

- The recommended minimum testing time for a simple withstand test on aged cable circuits is 30 min at 0.1 Hz (Goodwin, Oetjen, and Peschel [B13]). If a circuit is considered as important, e.g., feeder circuits, then consideration should be given to extending the testing time to 60 min at 0.1 Hz (Hampton, et al. [B19]).
- The recommended minimum testing time for an installation and/or acceptance withstand test on new cable circuits is 60 min at 0.1 Hz.
- A test time within the range 15–30 min may be considered if the monitored characteristic remains stable for at least 15 min and no failure occurs. It should be noted that the recommended test time for a withstand test is 30 min.

**Summary:** The intent of VLF Withstand Testing is to apply a sufficient test voltage for a long enough time to permit any defect big enough to be excited by the voltage applied to fail within the test duration. If a cable can't withstand the test voltage, let it fail and make the repair or replacement.

If the cable passes, there is a high assurance that the cable should not fail in service for many years.

**Diagnostic Testing:** If a pass/fail AC Withstand test is not desired, there are several Diagnostic Tests available. Using the VLF as the voltage source, Tangent Delta ( $\delta$ ) measurements and Partial Discharge detection can be performed with accessories available from HVI.

## Optional Accessories

### VLF and E-Series



#### Hand and Foot Safety Interlock Switches

Dead man style safety switches that connect to the external interlock provisions on the front panel of the VLF AC Hipot Test Set. The switch must be depressed before "HV On" and remain depressed during the duration of the testing. Releasing the switch has the same effect as hitting "HV Off", turning off the high voltage circuit. Supplied with 12 foot lead.



#### Grounding Sticks

Safely confirm the device under test has been discharged and is at ground potential before handling after testing.

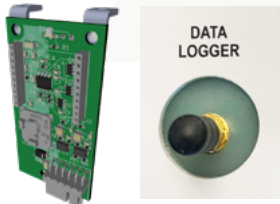

#### ADL-2

The ADL-2 is a data transmitter designed for our electro-mechanical VLF Series units. The data transmitter is installed in the front panel of the VLF unit and relays voltage, current, frequency and capacitance measurements to an app that is installed on a laptop. The app logs and records the data sent to it via the transmitter and allows for data visualization and reporting.



#### Reusable Shipping Cases

Reusable hard shipping cases designed for safe transportation of your VLF Series AC Hipot. Available for the VLF-30CM, VLF-34E, VLF-65E and some control sections.



#### Handcart

Optional handcart for increased portability of larger 2 piece VLF Models. VLF-4022CM, VLF-6022CM, and VLF-90CMF.

# PFT SERIES CONTENTS

Portable Power Frequency AC Hipots .....	24
PFT Series Advantages .....	24
Applications .....	25
High Voltage Configurations .....	26
Controls and Configurations .....	27
PFT Series Specifications .....	29
Optional Accessories .....	33
Optional Upgrades .....	34

# PORTABLE POWER FREQUENCY AC HIPOTS DESIGNED FOR THE RIGORS OF FIELD USE

Enhanced portability by efficient design. Our late founder, Stanley Peschel was unparalleled at designing reliable high voltage transformers in the smallest possible space. We continue on in his tradition.

The PFT Series from HVI are portable power frequency AC hipot test sets designed for a variety of field and repair shop testing applications. Built in the USA at our factory in upstate New York, these inexpensive, compact and light weight units are rugged and reliable. Models range from 10kV to 100kV and 1kVA to 3kVA of output power. The 3kVA models offer a gapped core high voltage transformer for up to 3 kVA of output power with the draw of only 1.5 kVA so the hipot can be powered by a standard 120Vac or 230Vac input. The 1 and 2 kVA models are straight power with no gapped core. All are equipped with transit protected and anti-static glass faced meters.

## PFT Series Advantages

The top seller among the PFT Series is the PFT-503CM. It is rated 50 kVAC @ 3kVA and is the only single piece, cable output unit in the world at this voltage and power level. Our competitors offer a two-piece design, with the combined size and weight of their controller and separate high voltage section nearly twice the PFT-503CM's size and weight. Portability and shielded output cable make the PFT-503CM the industry standard for testing 15 kV breakers. Our PFT-503CM is also equipped with a triple range current meter with a Guard/Ground circuit for precise leakage current measurements. Our PFT-103CM and PFT-303CM also share these same industry leading features.

The 1 piece 3kVA rated PFT Series models are equipped with a 20' shielded high voltage output cable and contain a fixed internal inductance to cancel out more than half the capacitive reactance of the load. With most AC testing, the load is capacitive. We can test a capacitive load drawing up to 3kVA output power but only pull about 1.5 kVA of input power. This advantage allows our 3kVA rated models to be plugged in to a standard outlet.

The PFT-302CE and PFT-401CE are purpose built for the testing requirements of the international market. These models offer a key operated on/off switch, digital meters, a 10-110% of rated output current adjustable overload, and are CE marked as required by international customer base. The PFT-302CE is terminated with an X-ray shielded output cable while the PFT-401CE has a small external high voltage section terminated with a 1.5 inch (38mm) aluminum ball.

Our 2 piece PFT-652CM and PFT-1003CM enjoy many of the same innovative features as the single piece models including:

- Secondary Connected 2 Range Voltmeter (analog 2kVA, 3kVA models only)
- 3 Range Current Meter (analog 2kVA, 3kVA models only)
- 3.5 Digit Digital Meters Optional
- Factory Fixed Overcurrent Overload



- Anti-static Glass Faced Volt and Current Meters
- Transit Protected Volt and Current Meters
- Guard/Ground Circuit for Accurate Current Measurement (2kVA, 3kVA, CE Marked models only)
- Gapped Core Transformer for Capacitive Current Compensation (3kVA models only)

## Applications

The PFT series was designed for testing resistive or light capacitive loads to maintain the ideal size and weight for field portability. These units are well suited for pass/fail, AC over-voltage withstand test on high voltage apparatus like vacuum bottles, interrupters, switchgear, circuit breakers, reclosers, hotline tools/safety products, short lengths of bus duct, small motors, small transformers, electrical components, and many other apparatus needing an AC test voltage.

When AC testing, most loads appear capacitive. To apply high voltage AC at power frequency (50/60 Hz) to a capacitive load requires higher power and current ratings from the test set when compared to DC. Unlike DC where the capacitance of the load only needs to be overcome once, as you slowly raise the output voltage, AC must overcome the capacitance 2 times per cycle. Once while reaching the desired test voltage on the positive side and the second while reaching the desired test voltage on the negative side of the sinewave after crossing the zero reference. The output power or kVA requirement may be very different depending on the load of the apparatus that is being tested.



Vacuum Bottles/Interrupters



Switchgear and Circuit Breakers



Substation Apparatus



Hotline Tools



Iso Phase Bus

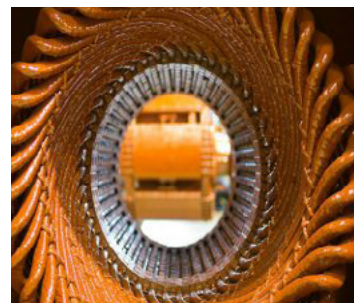

Small Motors/Generators



## High Voltage Section Configurations



### Cable Output

Shielded output cable standard up to 50kV (except PFT-401CE).



### Toroidal Output

Toroidal dish or ball termination on top of a fiberglass cylinder, standard on the PFT-401CE, PFT-652CM, and PFT-1003CM.

## Controls and Configuration

### PFT-103CM, PFT-303CM, and PFT-503CM

- Continuously adjustable output voltage
- Secondary connected 2 range analog voltmeter
- 3 range analog current meter
- Guard/ground circuit for accurate leakage current measurement
- Transit protected, glass faced meters to prevent damage in transit
- Fixed overload set to 120% of variable transformer rated output current
- Zero start safety interlock
- External interlock provisions

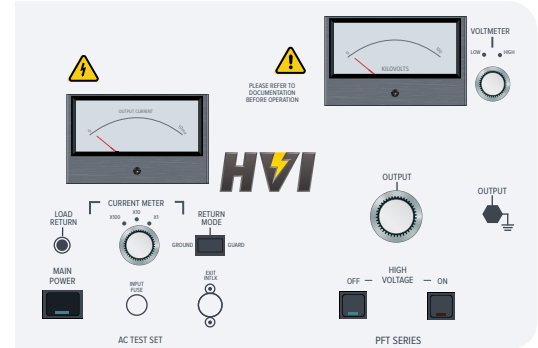

### PFT-652CM and PFT-1003CM

- Continuously adjustable output voltage
- Secondary connected 2 range analog voltmeter
- 3 range analog current meter
- Guard/ground circuit for accurate leakage current measurement
- Transit protected, glass faced meters to prevent damage in transit
- Fixed overload set to 120% of variable transformer rated output current
- Zero start safety interlock
- External interlock provisions

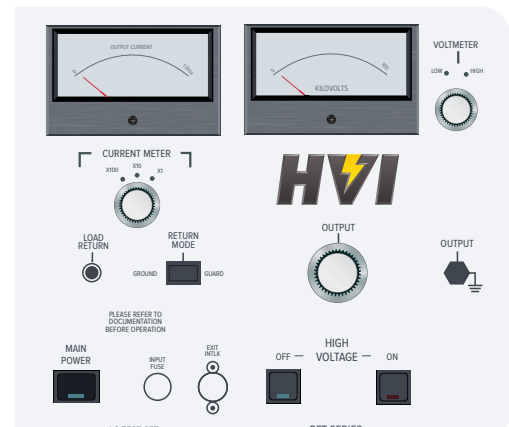

### PFT-301CM

- Continuously adjustable output voltage
- Primary connected single range analog voltmeter
- Single range analog current meter
- Transit protected, glass faced meters to prevent damage in transit
- Fixed overload set to 120% of variable transformer rated output current
- Zero start safety interlock
- External interlock provisions

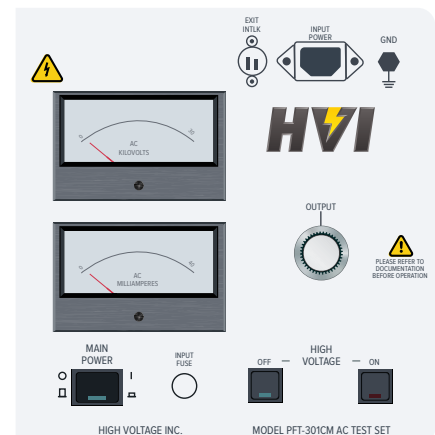

PFT-302CE

- Continuously adjustable output voltage
- Key operated main power switch
- Secondary connected single range 3.5 digit digital voltmeter
- Single range 3.5 digit digital current meter
- Guard/ground circuit for accurate leakage current measurement
- Transit protected, glass faced meters to prevent damage in transit
- Adjustable overload from 10 to 110% of rated output current
- Zero start safety interlock
- External interlock provisions

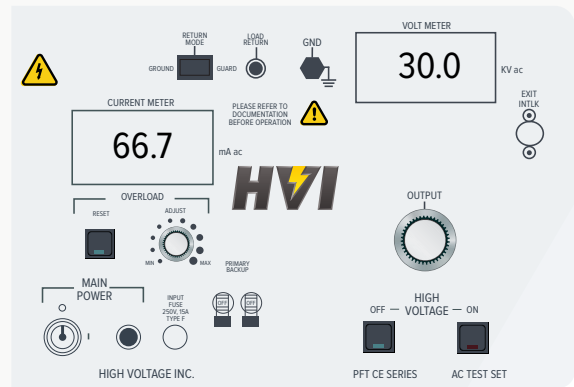

PFT-401CEF

- Continuously adjustable output voltage
- Key operated main power switch
- Emergency off mushroom switch for fast de-energizing of the high voltage output
- Secondary connected single range 3.5 digit digital voltmeter
- Single range 3.5 digit digital current meter
- Guard/ground circuit for accurate leakage current measurement
- Transit protected, glass faced meters to prevent damage in transit
- Adjustable overload from 10 to 110% of rated output current
- Zero start safety interlock
- External interlock provisions

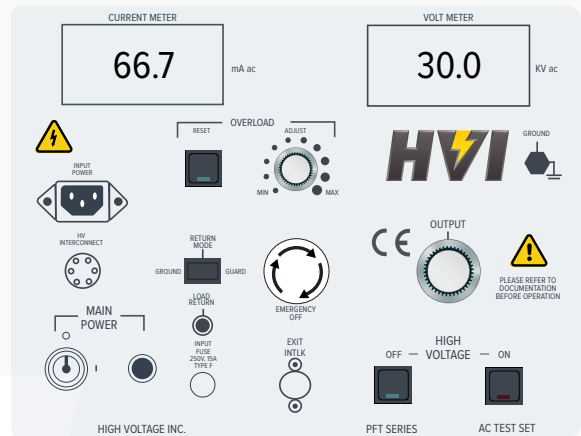

## PFT Series Specifications



**PFT-103CM**



**PFT-301CM**

### PFT-103CM

**Input:** 120 V, 60 Hz, 15 A (PFT-103CM)  
230 V, 50/60 Hz, 8 A (PFT-103CMF)

**Output:** 0-10 kV AC, 1 kVA resistive load  
3 kVA capacitive load  
Up to 300 mA current  
Output current is reduced at lower voltages

**Duty:** 3 kVA: 1 hour ON, 1 hour OFF  
1.5 kVA: continuous

**Voltmeter:** 3.5", scaled 0-5/10 kV AC,  $\pm 2\%$  F.S.

**Current Meter:** 3.5", scaled 0-1.0 mA,  $\pm 2\%$  F.S. with range multipliers of x1, x10, x100 guard/ground load return

**Distortion:** Less than 5%

**Size & Weight:** 21 x 11.25 x 15.25 in., 62 lb.  
534 x 286 x 387mm, 28 kg.

**Output Termination:** 20 ft. (6 m.) shielded EPR output cable with alligator clamp

**Scope of Supply:** 20 ft. black ground lead, 20 ft. shielded return cable, external interlock plug, operations manual, calibration certificate

### PFT-301CM

120 V, 60 Hz, 10 A (PFT-301CM)  
230 V, 50/60 Hz, 5 A (PFT-301CMF)

0-30 kV AC, 1 kVA resistive load  
1 kVA capacitive load, 33 mA current

1 kVA: 1 hour on, 1 hour off  
700 VA: Continuous

3.5", scaled 0-30 kV AC,  $\pm 2\%$  F.S.

3.5", scaled 0-40 mA,  $\pm 2\%$  F.S.

Less than 5%

17 x 11.5 x 14 in., 45 lb.  
431 x 292 x 365mm, 20 kg.

20 ft. (6 m.) shielded silicone output cable with alligator clamp

20 ft. black ground lead, external interlock plug, operations manual, calibration certificate



**PFT-302CE**



**PFT-303CM**

## PFT-302CE

**Input:** 230 V, 50/60 Hz, 15 A

**Output:** 0-30 kV AC, 2 kVA resistive load  
2 kVA capacitive load, up to 67 mA current

**Duty:** 0-30 kV AC, 2 kVA resistive load  
2 kVA capacitive load, up to 67 mA current

**Voltmeter:** 3.5 digit LED, scaled 0-30 kV AC,  $\pm 1\%$  F.S.

**Current Meter:** 3.5 digit LED, scaled 0-67 mA AC,  $\pm 1\%$  F.S.

**Distortion:** Less than 5%

**Size & Weight:** 23 x 11.5 x 15.5 in., 62 lb.  
584 x 292 x 394mm, 28 kg.

**Output Termination:** 20 ft. (6 m.) output cable with alligator clamp

**Scope of Supply:** 20 ft. green/yellow ground lead, 20 ft. shielded return cable, external interlock plug, main power key, operations manual, calibration certificate

## PFT-303CM

120 V, 60 Hz, 15 A (PFT-303CM)  
230 V, 50/60 Hz, 8 A (PFT-303CMF)

0-30 kV AC, 1 kVA resistive load:  
3 kVA capacitive load, up to 100 mA current  
Output current is reduced at lower voltages

3 kVA: 1 hour ON, 1 hour OFF  
1.5 kVA: continuous

3.5", scaled 0-12/30 kV AC,  $\pm 2\%$  F.S.

3.5", scaled 0-1 mA,  $\pm 2\%$  F.S. with range multipliers of x1, x10, x100 guard/ground load return

Less than 5%

21 x 11.25 x 15.25 in., 75 lb.  
534 x 286 x 387mm, 34 kg.

20 ft. (6 m.) output cable with alligator clamp

20 ft. black ground lead, 20 ft. shielded return cable, external interlock plug, operations manual, calibration certificate

## PFT Series Specifications



**PFT-401CEF**



**PFT-503CM**

### PFT-401CEF

**Input:** 230Vac, 50/60Hz, 6A

**Output:** 0-40kV AC, 1kVA resistive load (25mA Max)  
1kVA capacitive load (25mA max)

**Duty:** 1 kVA: 1 hour ON, 1 hour OFF  
0.8kVA: continuous

**Voltmeter:** 3.5" digital LED, scaled 0-40kV AC (RMS)

**Current Meter:** 3.5 digit LED, scaled 0-25ma AC (RMS)

**Distortion:** Less than 5%

**Size & Weight:** 14.5 x 12.5 x 23.5 in., 70 lb.  
368 x 318 x 597mm, 32 kg.

**Output Termination:** Top mounted 1.5 in. aluminum ball

**Scope of Supply:** (2) 20 ft. green/yellow ground leads, 20 ft. shielded return cable, external interlock plug, operations manual, calibration certificate

### PFT-503CM

120 V, 60 Hz, 15 A (PFT-503CM)  
230 V, 50/60 Hz, 8 A (PFT-503CMF)

0-50 kV AC, 1 kVA resistive load  
3 kVA capacitive load, up to 60 mA current  
Output current is reduced at lower voltages

3 kVA: ½ hour ON, 2 hours OFF  
2 kVA: 1 hour ON, 1 hour OFF  
1 kVA: continuous

3.5", scaled 0-25/50 kV AC, ±2% F.S.

3.5", scaled 0-1 mA, ±2% F.S. with range multipliers of x1, x10, x100

Less than 5%

21 x 11.25 x 15.25 in., 75 lb.  
534 x 286 x 387mm, 34 kg.

20 ft. (6 m.) shielded output cable with alligator clamp

20 ft. black ground lead, 20 ft. shielded return cable, external interlock plug, operations manual, calibration certificate



**PFT-652CM**



**PFT-1003CM**

## PFT-652CM

**Input:** 120 V, 60 Hz, 15 A (PFT-652CM)  
230 V, 50/60 Hz, 8 A (PFT-652CMF)

**Output:** 0-65 kV AC, 2 kVA resistive load  
2 kVA capacitive load, up to 30 mA current  
Output current is reduced at lower voltages

**Duty:** 2 kVA: 1 hour ON, 1 hour OFF  
1.5 kVA: continuous

**Voltmeter:** 3.5", scaled 32.5/65 kV AC,  $\pm 2\%$  F.S

**Current Meter:** 3.5", scaled 0-1 mA,  $\pm 2\%$  F.S. with range multipliers of x1, x10, x100

**Distortion:** Less than 5%

**Size & Weight:** Control: 16.5 x 10.13 x 10.15 in., 34 lb.  
420 x 260 x 260mm, 15 kg.

HV Tank: 12 x 13 x 13.5 in., 50 lb.  
310 x 330 x 350mm, 23 kg.

**Output Termination:** Top Toroid

**Scope of Supply:** 20 ft. black ground lead, 20 ft. shielded return cable, external interlock plug, operations manual, calibration certificate

## PFT-1003CM

120 V, 60 Hz, 15A (PFT-1003CM)  
230 V, 50/60 Hz, 8A (PFT-1003CMF)

0-100 kVac, 1 kVA resistive load  
3 kVA capacitive load, up to 30 mA current  
Output current is reduced at lower voltages

3 kVA: 1 hour ON, 1 hour OFF  
1 kVA: continuous

3.5 inch Scaled 0-50/100 kVac

3.5 inch Scaled 0-1.0 mAac, with x1, x10, x100 Range Multiplier

Less than 5%

Control: 21 x 11.25 x 15.25 in, 245 lb.  
533 x 286 x 387mm, 111 kg.

HV Tank: 13 x 13 x 22 in., 82 lb.  
330 x 330 x 559mm, 38 kg.

Top Toroid

20 ft. black ground lead, 20 ft. shielded return cable, external interlock plug, operations manual, calibration certificate

## Optional Accessories



### Hand and Foot Safety Interlock Switches

Dead man style safety switches that connect to the external interlock provisions on the front panel of the PFT AC Hipot Test Set. The switch must be depressed before "HV On" and remain depressed during the duration of the testing. Releasing the switch has the same effect as hitting "HV Off", turning off the high voltage circuit. Supplied with 12 foot lead.



### Grounding Sticks

Safely confirm the device under test has been discharge and is at ground potential before handling after testing.



### Handcart

Optional handcart for increased portability of larger 2 piece PFT-652CM and PFT1003CM.



### Reusable Shipping Center

Reusable hard shipping cases designed for safe transportation of your PFT Series AC Hipot.

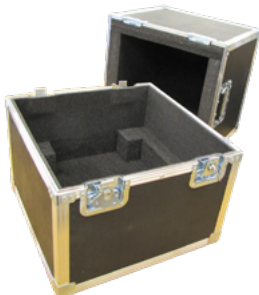



## Optional Upgrades



### Digital Metering

Add 3.5-digit digital meters to models with analog meters as standard equipment. Deletes or alters volt and/or current meter range switches.



### BURN Circuit

An optional BURN reactor provides the ability to enable current limiting of the output for burning a fault within the device under test in order to locate it. The OVERLOAD function is disabled when BURN is ON. Available on all control packages.

# HPA SERIES CONTENTS

- AC Dielectric Test Sets ..... 36
- Controls and Configurations ..... 38
- High Voltage Section Configurations ..... 43
- AC Dielectric Models and Specs ..... 44
- Specialty Applications ..... 46
- Optional Accessories ..... 48

# DURABLE AC DIELECTRIC TEST SETS FOR PRODUCTION, WITHSTAND, PARTIAL DISCHARGE, AND OTHER DIAGNOSTIC TESTING

HVI offers a full line of AC Dielectric Test Sets up to 300 kV in voltage and 40 kVA in power designed for over voltage withstand testing for sample or production testing applications. These higher power AC dielectric test sets are commonly used for testing capacitors, insulators, switchgear, buss duct, hot-line tools, aerial lifts, bucket liners, transformers and other loads that draw more current than a conventional AC hipot can output. Specialty models also available designed specifically for motor winding, ASTM D149 testing, or as a power supply for performing Tan Delta, Power Factor, Partial Discharge, or other type of diagnostic testing. The HPA series are designed and built in the USA. Depending on voltage and power they will have a steel tank or fiberglass HV section. Several full featured controller designs allow the user to choose the level of automation needed for their application. The high voltage sections are also available for integration into larger custom OEM systems, such as dielectric testing of rubber gloves, aerial lift liners, hot sticks, and other OEM applications. If lower power models are sufficient for your application, then consider our standard, portable PFT Series of 1 kVA and 3 kVA AC Hipots, available from 10 kV – 100 kV or ALT Series of 7kVA AC Hipots.

## How to Select an AC Dielectric Test Set?

### Don't Undersize The Set

AC high voltage testing requires higher power and current ratings when compared to DC testing the same test object. There are several parameters that must be considered when selecting an AC hipot or dielectric test set, the most important one being the capacitance of the load. This capacitance dictates the amount of output power, or the relationship of the amount of current drawn by the device under test to the specified test voltage required from the test set. Following are several considerations when specifying a test set:

### Voltage Output

Select a test set with 20 – 25% more voltage than your requirement for enough voltage headroom to compensate for any possible future changes in testing standards or the testing application. The output current of the test set is based on the kVA, or Power rating at full voltage. Any increase in the output voltage rating for the same kVA rated test set will proportionately decrease the current rating.



HPA-10020CF3

## Power/Current Rating

The HPA series are listed by their kVA, or power rating. Power rating, or kVA is calculated by multiplying the maximum output voltage by the maximum output current. When AC testing, most loads appear capacitive. To apply high voltage AC at power frequency, 50 or 60 Hz to a capacitive load requires higher power and current ratings from the test set than most portable AC hipots can typically supply. The capacitance of the load must be known in order to calculate the required current at the desired test voltage. Select a test set, with at least 20 - 25% extra power than believed needed. To determine the current needed from the test set, the following formula should be used:



HPA-1005C5D149

$$A = 2\pi fCV$$

**A = Test current required in Amps (A)**

**f = Test frequency in Hertz (Hz)**

**C = Load capacitance in Farads (F)**

**V = Test voltage in volts (V)**

Another way to determine the current needed at the required test voltage is to apply a lower voltage to the load and measure the current. The current draw of the device under test at the actual higher test voltage should be a linear increase. For example, if your test load draws 10 mA @ 5 kV it will draw approximately 100 mA @ 50 kV. An AC test set is a constant current device, the maximum output current is the same at any output voltage.

## Duty Cycle

Most AC dielectric strength testing is short duration testing performed for 60 seconds at a time, however, production testing may require consecutive tests over many hours. Most HPA AC test sets are rated for 50% duty. The full power rating can be delivered for one hour on followed by one hour off. Most HPA AC test sets are rated for continuous duty at approximately 80% of the full power rating.

## Partial Discharge Requirements

Many of the HPA Series AC test sets are rated for <10pc of partial discharge at full output voltage. Models with an oil filled steel tank and using an output bushing are rated to <10pc, while models with fiberglass HV sections and/or a cable output are not PD rated. <5pc of partial discharge is available upon request.



HPA-1010FC3

## Summary

When performing an AC Withstand, Power Factor, Tan Delta, or Partial Discharge testing on MV/HV apparatus, aerial lifts, motors, generators, or cable, the AC charging current can be high depending on the capacitance of the device under test. The test voltage is determined by the applicable test standard. The expected or real current draw of the test load at your test voltage and/or capacitance of the device under test must be known to size the set.

## Customizable Controls and Configurations

### Five Control Packages; Variations Available on Custom Basis

Various control packages are available, from simple manual controls to fully programmable logic control (PLC) options.

#### C1 Controls: Simplified Controls w/manual output voltage control – up to 5 kVA

- Voltage meter: two range
- Current meter: three range
- Main Power breaker/indicating light
- HV On/Off
- Output Adjust control knob
- Variable Overload w/reset, 10-110% of rated output current
- External interlock provisions

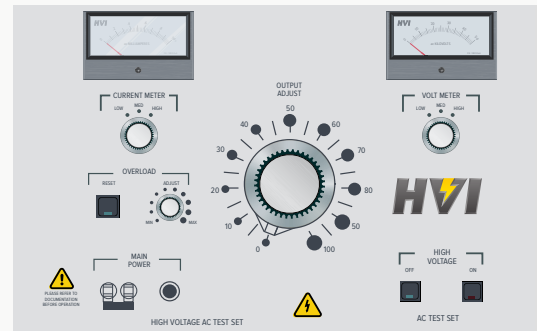

#### C2 Controls: Simplified Controls w/motorized output voltage control – up to 10 kVA

- Voltage meter: two range
- Current meter: three range
- Control Power breaker/indicating light
- HV On/Off
- Voltage Raise/Lower control
- Fixed voltage rate-of- rise
- Variable Overload w/reset, 10-110% of rated output current
- Emergency Off button
- External interlock provisions



### C3 Controls: Automatic Controls with 3.5 Digit Digital Metering – any kVA

- Voltage meter: digital 3.5 digits
- Current meter: digital 3.5 digits
- Control Power breaker
- HV On/Off
- Output Mode: Manual/Auto
- Output Voltage: Raise/Lower control Four fixed volts/second rates-of-rise 10 – 100 seconds, consult factory
- Test Dwell timer
- Variable Overload w/reset, 10-110% of rated output current
- Emergency Off button
- External interlock provisions

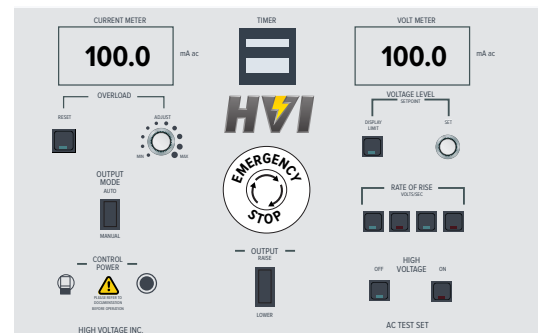

### C4 Controls: Automatic Controls with 4.5 Digit Digital Metering – any kVA

This is the same functionality as the C3 control package with 4.5 digit meters. The 4.5 digit meters instead of 3.5 digits offer a higher resolution in reading the voltage and current displayed.

- Voltage meter: digital 4.5 digits
- Current meter: digital 4.5 digits
- Control Power breaker
- HV On/Off
- Output Mode: Manual/Auto
- Output Voltage: Raise/Lower control Four fixed volts/second rates-of-rise 10 – 100 seconds, consult factory
- Test Dwell timer
- Variable Overload w/reset, 10-110% of rated output current
- Emergency Off button
- External interlock provisions

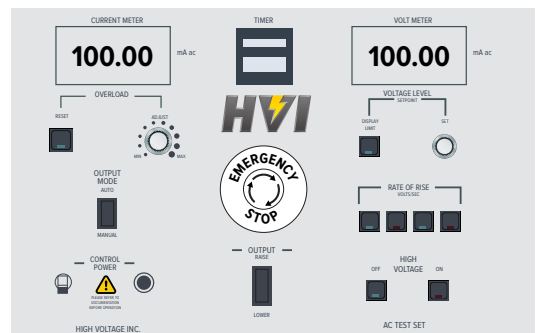

## C5 Controls - PLC programmed and controlled – any kVA

The C5 PLC controller provides an on-board PLC for complete operational and programming control and includes a PC interface to download tests results for report generation. The PLC can fully automate repetitive testing in automatic mode or perform simple hipot tests in manual mode. Test profiles for automatic mode can be preset at the factory or can be entered via the touch screen control. Operation is easily modified using Ladder Logic Programming. The C5 controller allows the user to fully program the operation of the set from the PLC and allows complete downloading of test results for report generation using your reporting software.

- 320 x 240 color touch screen display for programming and operation
- Graphical display of output voltage and current during test
- Output voltage and current final test results displayed
- PC Interface for data download via RS-232
- Save and recall test profiles easily
- External interlock provisions

### User Selectable/Settable Parameters:

- Automatic or Manual Mode
- Voltage set point
- Over Current set point
- Test Dwell Timer
- Voltage Rate of Rise (10-100 Seconds)

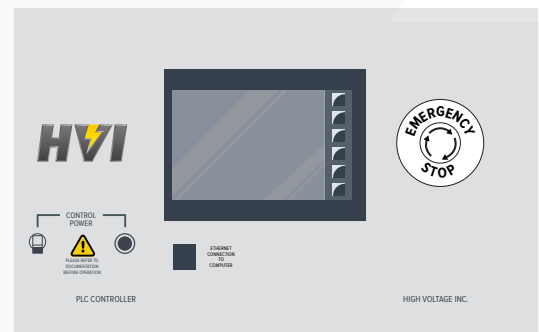

## Optional Upgrades

### PLC Interface

A C3 or C4 controller that also offers input and output control provisions to interface with a remote programmable logic controller (PLC) or some other customer supplied controller. It can be operated in the Local mode using the front panel controls or in the Remote mode via customer supplied external controls. Includes 0-10Vdc Input Control and Output Feedback signals, permitting the remote control over the dielectric test set for most functions with output signals to communicate to an external customer supplied PLC controller. When in the REMOTE mode, all front panel controls are disengaged except for the Emergency Off, Voltmeter and Current meter. Available only on the C3 and C4 control packages.

#### Input Remote Control Signals

- Contact N/O: Close HV ON - Open HV OFF
- Rate of Rise: 0-10V = 10s – 100s to full output
- Contact N/O: RAISE – Close to operate
- Contact N/O: LOWER – Close to operate
- Contact N/C: Overload Reset – Open to operate
- Overload Set Point: 0-10Vdc = 10 - 110% current

#### Output Feedback Signals

(N/O = normally open, N/C = normally closed)

- Remote Enabled: N/O
- Main Power ON: N/O
- High Voltage ON: N/O
- Overload FAULT: N/O
- Voltage: 0-10Vdc = 0 - 100% output voltage
- Current: 0-10Vdc = 0 - 100% output current
- Voltage return to 0 (automatic after overload): N/O

**N/O = normally open**  
**N/C = normally closed**

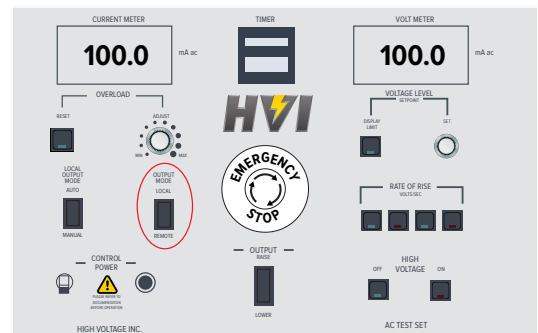

### BURN Circuit

An optional BURN reactor provides the ability to enable current limiting of the output for burning a fault within the device under test in order to locate it. The OVERLOAD function is disabled when BURN is ON. Available on all control packages.



### Guard Circuit

Adds Guard circuit to the current metering circuit. Used for measuring accurate leakage current of the device under test by shunting ground current around the current meter.



### Flashing Warning Light

Flashing Red Warning Lamp that illuminates when the high voltage circuit has been energized. Available on all control packages.





## Safety Light Stack

Status light option, illuminates green when the high voltage circuit is not energized and illuminates red when the high voltage circuit is energized. Available on all control packages.



## Safety Key Interlock Switch

Front panel mounted key operated interlock switch. Available on all control packages.



## Casters

2 inch or 6 inch casters mounted under the Control and/or High Voltage Section. Available on all control packages.



## 4 Wheel Push Cart

Two piece HPA steel tank models can be mounted on a 4 wheel push cart with pneumatic tires for portability in the field or factory. Consult factory for availability.

## High Voltage Section Configurations

Except for the lowest voltage 5 kVA, 10 kVA, and 20 kVA models that contain the HV section within the control cabinet, all models have a separate HV section. There are two HV section designs, a steel tank with a bushing output and a fiberglass cylinder with a toroid/spinning output. A steel tank with a cable output on models rated up to 50 kV is possible on a custom basis. No HV output cable is provided on bushing and spinning output models.

A half voltage, full kVA secondary output is optional on many of the HPA AC Dielectric Test Sets. This allows for lower voltage but higher current testing when compared to the full voltage, full kVA output tap. Both output voltage taps will be active at the same time. The pictures below for examples of the various layout configurations.



### Cable Output

Standard on 10kV and below up to 20kVA. Optional half voltage, full kVA separate output tap available. No PD Spec.



### Bushing Output

Standard on 10kV to 150kV, Optional 10kV and below. Optional half voltage, full kVA separate output tap available. PD free at less than 10pc. Less than 5pc available upon request.



### Toroidal Output

200kV and above. Optional half voltage, full kVA separate output tap available on some models, consult factory. , No PD Spec.

## Matrix of Models/Specs

### AC Dielectric Models:

#### 5kVA

- Input: 230V, 50/60Hz, 1 Ph, 25A
- Duty: 5kVA 1 hr. On / 1 hr. Off, 4 kVA Continuous

Volt (kV)	Model	Current mA	Control Section				HV Section				Type
			W in/mm	D in/mm	H in/mm	WT LBS/KG	W in/mm	D in/mm	H in/mm	WT LBS/KG	
10	HPA-105FC*	500	21/533	25/635	30.5/775	200/91	none - one piece design				NA
30	HPA-305FC*	167	•	•	•	75/34	13/330	13/330	21/533	95/43	steel
50	HPA-505FC*	100	•	•	•	75/34	13/330	13/330	21/533	95/43	steel
75	HPA-755FC*	67	•	•	•	75/34	13/356	13/356	21/635	95/43	steel
100	HPA-1005FC*	50	•	•	•	145/66	18.5/470	18.5/470	34/864	300/136	steel

- C1 Controls: 21" W x 16" D x 15" H. 533 mm W x 406 mm D x 381 mm H
- C2, 3, 4, or 5 Controls: 21" W x 25" D x 30.5" H. 533 mm W x 635 mm D x 775 mm H

#### 10kVA

- Input: 230V, 50/60Hz, 1 Ph, 50A
- Duty: 10kVA 1 hr On / 1hr Off, 8 kVA Continuous

Volt (kV)	Model	Current mA	Control Section				HV Section				Type
			W in/mm	D in/mm	H in/mm	WT LBS/KG	W in/mm	D in/mm	H in/mm	WT LBS/KG	
10	HPA-1010FC*	1000	21/539	25.5/648	47.3/1200	390/177	none - one piece design				NA
30	HPA-3010FC*	333	21/533	25/635	30.5/775	200/91	13/330	13/330	25/635	215/97	steel
50	HPA-5010FC*	200	21/533	25/635	30.5/775	200/91	13/330	13/330	25/635	215/97	steel
75	HPA-7510FC*	133	21/533	25/635	30.5/775	200/91	17/432	17/432	32/813	275/125	steel
100	HPA-10010FC*	100	21/533	25/635	30.5/775	200/91	18/457	18/457	37.5/953	325/147	steel
150	HPA-15010FC*	67	21/533	25/635	30.5/775	200/91	22/559	33/838	48/1219	700/317	steel

\*Insert a 1, 2, 3, 4, or 5 to the model number in place of the \* to specify which controller, described starting on page 4.

\*OPTION: On 5 kVA - 40 kVA models, a 50% voltage tap rated full kVA is optional, consult factory

## 20kVA

- Input: 230V, 50/60Hz, 1 Ph, 90A
- Duty: 20kVA 1 hr On / 1hr Off, 16 kVA Continuous

Volt (kV)	Model	Current mA	Control Section				HV Section				Type
			W in/mm	D in/mm	H in/mm	WT LBS/KG	W in/mm	D in/mm	H in/mm	WT LBS/KG	
10	HPA-1020FC*	2000	21/559	25.5/648	47.3/1200	530/241	none - one piece design				NA
30	HPA-3020FC*	667	21/559	25.5/648	47.3/1200	300/136	17/432	17/432	25/635	300/136	steel
50	HPA-5020FC*	400	21/559	25.5/648	47.3/1200	300/136	17/432	17/432	25/635	300/136	steel
75	HPA-7520FC*	267	21/559	25.5/648	47.3/1200	300/136	17/432	17/432	25/635	325/147	steel
100	HPA-10020FC*	200	21/559	25.5/648	47.3/1200	300/136	18.5/470	18.5/470	37.5/953	375/170	steel
150	HPA-15020FC*	133	21/559	25.5/648	47.3/1200	300/136	29/737	30/762	56/1422	1050/476	steel
200	HPA-20020FC*	100	21/559	25.5/648	47.3/1200	300/136	28/711	28/711	56.5/1435	1120/508	fiber-glass
300	HPA-30020FC*	67	21/559	25.5/648	47.3/1200	300/136	28/711	28/711	82/2083	1600/726	fiber-glass

## 40kVA

- Input: 230V, 50/60Hz, 1 Ph, 180A
- Duty: 40kVA 1 hr On / 1hr Off, 32 kVA Continuous

Volt (kV)	Model	Current mA	Control Section				HV Section				Type
			W in/mm	D in/mm	H in/mm	WT LBS/KG	W in/mm	D in/mm	H in/mm	WT LBS/KG	
10	HPA-1040FC*	4000	22/559	31/787	67/1702	500/227	28/711	21/533	32/813	850/385	steel
30	HPA-3040FC*	1333	22/559	31/787	67/1702	500/227	28/711	21/533	32/813	865/392	steel
50	HPA-5040FC*	800	22/559	31/787	67/1702	500/227	28/711	21/533	32/813	875/397	steel
75	HPA-7540FC*	533	22/559	31/787	67/1702	500/227	28/711	21/533	37/940	550/250	steel
100	HPA-10040FC*	400	22/559	31/787	67/1702	500/227	28/711	21/787	45/1143	1100/499	steel
150	HPA-15040FC*	267	22/559	31/787	67/1702	500/227	28/711	21/787	58/1473	1315/596	steel

\*Insert a 1, 2, 3, 4, or 5 to the model number in place of the \* to specify which controller, described starting on page 4.

\*OPTION: On 5 kVA - 40 kVA models, a 50% voltage tap rated full kVA is optional, consult factory

## Specialty Applications

### ASTM D149 Testing

HVI offers custom AC Dielectric test sets purpose built for the testing of solid dielectric insulations at power frequency per the ASTM D149 standard, up to 100kV AC. Equipped with an interlocked test chamber, test chamber viewing window, optional custom test fixtures or an optional oil bath. Offered with C3, C4, or C5 control packages based on your testing needs. HVI has what you need for testing insulation films, sheets, mylars or other solid dielectric insulations. Consult factory for more information on custom ASTM D149 testing systems.



HPA-1005C5D149

### AC Motor/Generator Testing

Motors and generators have some very specific high current test requirements, for this HVI offers the HPA-033MF which offers 0-3kV AC at 3kVA with up to 1 Amp of output current and the HPA-055MF which offers 0-5kV AC at 5kVA also with up to 1 Amp of available output current. Ready for field or factory use, these units are built into an upright cart for portability, terminated with a shielded output cable, the C1 control package, a burn circuit, and flashing warning light. For up to 12kV needs, HVI offers the [FPA-12/066F](#) which offers a dual output, 0-6kV AC at 6kVA with up to 1 amp and 0-12kV at 6kVA with up to 500mA of available output current. The FPA-12/066F is also built onto a cart, equipped with a C1 control package, a burn circuit, a guard circuit, and an safety light stack which make it ideal for field or factory testing as well.



HPA-055MF

Volt (kV)	Model	Current mA	W in/mm	D in/mm	H in/mm	WT LBS/KG
3	HPA-033MF	1000	14.5/370	21/535	48/1220	140/64
5	HPA-055MF	1000	14.5/370	21/535	48/1220	140/64
6/12	FPA-12/066F	1000/500	23/580	23.5/600	46/1170	215/98



## AC Withstand & Diagnostic Assessment Testing

0 - 6 kVac @ 1 A & 0 - 12 kVac @ 500 mA

## FPA-12/066F

0 - 6 kVac @ 1 A & 0 - 12 kVac @ 500 mA

The model **FPA-12/066F** AC Dielectric Test Set provides continuously adjustable AC high voltage to perform pass/fail AC Withstand testing and for use as a voltage source for diagnostic testing of high voltage apparatus, like motor & generator windings, bus duct, switchgear, etc. The **FPA-12/066F** is rated for 6 kVA of test power from two full kVA outputs: **0 - 6 kVac @ 1 amp and 0 - 12 kVac @ 500 mA**. It offers the motor test features needed, the convenience of a shielded EPR output cable, and is corona free to < 10 pc. It is provided in a mobile, rugged, and reliable package.

- Two Full kVA Voltage Outputs
- Low Partial Discharge output <10 pc
- Voltage Output Selected LEDs
- Adjustable Overload from 10% – 110%
- Overload Backup at 120% of primary current
- Load Burn mode to help find faults
- Shielded output cable for ease in use
- Keyed Emergency Off switch
- Zero Start & External Interlock
- Rugged Metering - Digital Optional
- Warning Lights - Green & Red
- Isolated Load Return with Guard/Ground switch
- Three Range Volt Meter and Current Meter
- Simple, manual controls for ease in use - no programming

<b>Model</b>	<b>FPA-12/066F</b>
<b>Input</b>	230 V, 26 amps, 50/60 Hz, single phase
<b>Output</b>	0 - 12 kVac @ 500 mA or 0 - 6 kVac @ 1000 mA
<b>Duty Cycle</b>	6 kVA @ 1 hr. ON/1 hr. OFF, 5 kVA continuous
<b>Voltmeter</b>	3.5" Analog with scaling of 0 - 3/6/12 kVac
<b>Current Meter</b>	3.5" Analog Scaled 0-250/500/1000 mA ac Guard/ground load return
<b>Size &amp; Weight (W x D x H)</b>	20.5 x 23 x 47 in., 235 lb. (height incl. warning lamps) 521 x 584 x 1245 mm, 107 kg
<b>Output Termination</b>	20ft/6m EPR Shielded output cable with battery clamp
<b>Scope of Supply</b>	Ground Cable Connection External Interlock Connection Load Return BNC for Guarded Current Input Power cable

### Optional Accessories & Upgrades

#### Hand & Foot Safety Switches



PN 90-405

PN 90-410

#### Safety Ground Sticks



PN 88-150 Included

PN 88-113

### Optional Upgrades

3.5 Digit Digital Meters - Add Suffix "D"



HVI IS AN ISO 9001 REGISTERED COMPANY

## Optional Accessories



### **DVR Series**

The DVR-150 and DVR-300 are precision voltage dividers used to verify the voltage calibration of your HPA AC Dielectric Test Set.



### **Grounding Sticks**

Safely confirm the device under test has been discharge and is at at ground potential before handling after testing.



### **Hand and Foot Safety Interlock Switches**

Dead man style safety switches that connect to the external interlock provisions on the rear terminal block of the HPA AC Dielectric Test set The switch must be depressed before "HV On" and remain depressed during the duration of the testing. Releasing the switch has the same effect as hitting "HV Off", turning off the high voltage circuit. Supplied with 12 foot lead.

# PAR SERIES CONTENTS

AC Dielectric Test Sets for High Capacitance Loads with Less Power ...	50
Why Resonant Technology? .....	51
Calculating Test Currents .....	51
Controls and Configurations .....	52
Models and Specifications .....	53
High Voltage Section Configurations .....	54
Optional Accessories .....	55



# HVI – AC DIELECTRIC TEST SETS FOR HIGH CAPACITANCE LOADS WITH LESS POWER

The PAR Series models are high voltage AC Dielectric Test Sets used for testing many types of utility substation apparatus, aerial lifts, cables, and other loads requiring power frequency AC voltage to perform Withstand/Proof testing and Diagnostic testing: Partial Discharge and Tan Delta/Power Factor. This model line provides a high power and high voltage AC output like conventional 50/60 Hz. test sets. However, the PAR Series is of unique design intended to test highly capacitive apparatus and cables. Its design tests these loads while minimizing the input power, size, weight, and cost of the supply. The PAR Series uses Resonant Technology, specifically: Variable Inductance Parallel Resonance.

## Features

- Full Featured PLC Controller
- Auto/Manual Output Mode selection
- Continuously adjustable motorized output voltage control
- Programmable output Rate of Rise: 500 – 5000 volts/second
- Fixed primary current overload, factory set to 120% of current
- Adjustable secondary current overload: 10-110% of rating
- “Zero Start” and External Interlock provision
- Secondary connected volt and current meters



## Typical Testing Applications



ISO Phase Bus & Switchgear Testing

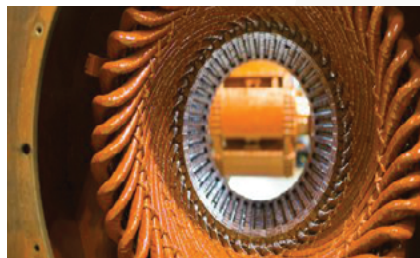

Motor & Generator Coil Testing



Cable Testing

## Why Resonance Technology?

### High Voltage Testing With Less Power, Current and Costs

Resonance Technology is used to AC test highly capacitive electrical apparatus or power cable using 50/60 Hz. power frequency. The charging currents of these capacitive loads are typically very high, requiring AC hipots to be rated for hundreds of kVA in power. Resonant technology uses basic and long proven electrical principles for its design and operation to reduce the levels of power consumption needed, permitting high voltage AC testing to be performed more economically than otherwise possible.

If the capacitive nature of the load can be compensated for by inserting an equivalent inductance in series or parallel, then the input power and current required to the supply is greatly reduced. By “tuning” the inductance of the test set to match the capacitance of the load, a controlled Resonance is achieved, High voltage can be applied with far less current and power source than otherwise possible.

Using the PAR Series, the input current required of the supply is typically 10x – 30x less than if conventional fixed inductance power supplies were used. The HV transformer, or reactor, design includes a variably adjustable air gapped steel core to alter the Inductance of the system to compensate for the Capacitance of the load tested. The intention is to create a controlled resonance situation where  $L = C$ , leaving only the resistive elements of the load needing current/ power from the test set.

## Calculating Test Currents

$$\text{Amps} = 2\pi f C V \text{ or } A = \omega C V \quad \omega \text{ (omega)} = 2\pi f$$

$f$  = Test frequency in Hertz (Hz)

$C$  = Load capacitance in Farads (F)

$V$  = Test voltage in volts (V)

Resistance =  $R$ ,  $X_L = \omega L$ ,  $X_C = 1/\omega C$   
 $\omega = 2\pi f$  ( $f$  = frequency)  
 $\omega$  for 50 Hz. = 314  $\omega$  for 60 Hz. = 377

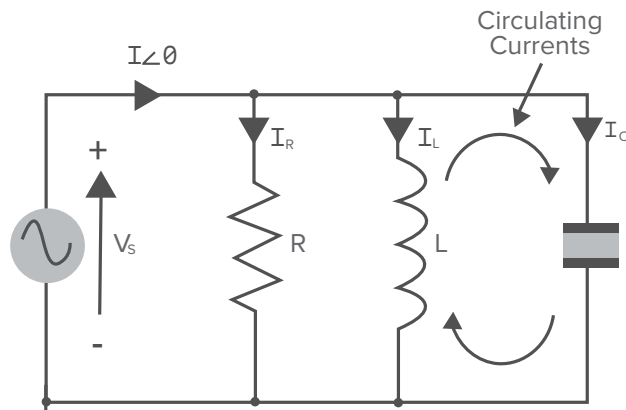

## Quality Factor "Q"

The Quality "Q" Factor is a measure of the level of power input reduction to the test set to deliver the power needed for a test. The Q, or quality, factor of a resonant circuit is a measure of the purity, or quality, of a resonant circuit. Q is the ratio of power stored (reactance) to power dissipated (resistance). In a parallel resonant circuit, the power, or kVA, across the load is approximately Q times the total system input power.

For example:

1. A circuit with a Q of 20 would draw 1 kVA of input power from the mains for approximately 20 kVA of reactive power across the load.
2. A parallel resonant set, rated for 50 kVac @ 5 A output, tuned to the capacitive reactance of a bus duct or switchgear could deliver 250 kVA of apparent power to the load while drawing less than 10 kVA of power from the utility mains.
3. A generator stator winding, with a typical Q of 10, would draw less than 11 kVA from the mains while 100 kVA of reactive power is applied to the coils.

## Controls and Configuration

### C5 Controls - PLC programmed and controlled – any kVA

The C5 PLC controller provides an on-board PLC for complete operational and programming control and includes a PC interface to download tests results for report generation. The PLC can fully automate repetitive testing in automatic mode or perform simple hipot tests in manual mode. Test profiles for automatic mode can be preset at the factory or can be entered via the touch screen control. Operation is easily modified using Ladder Logic Programming. The C5 controller allows the user to fully program the operation of the set from the PLC and allows complete downloading of test results for report generation using your reporting software

- 320 x 240 color touch screen display for programming and operation
- Graphical display of output voltage and current during test
- Output voltage and current final test results displayed
- PC Interface for data download via RS-232
- Save and recall test profiles easily
- External interlock provisions

User Selectable/Settable Parameters:

- Automatic or Manual Mode
- Voltage set point
- Over Current set point
- Test Dwell Timer
- Voltage Rate of Rise (10-100 Seconds)

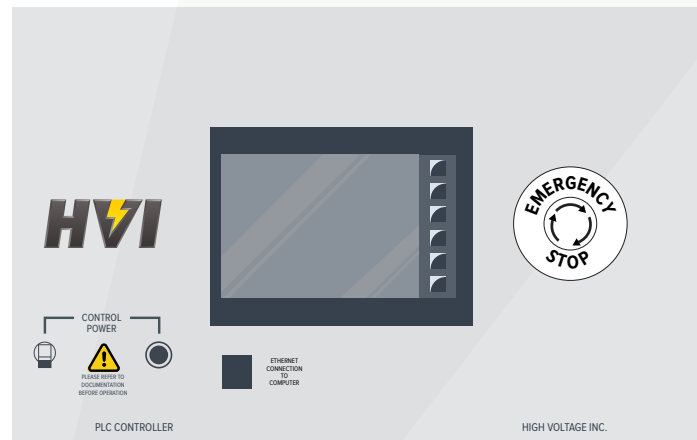

## Controls and Configuration

The model ratings offered by HVI are designed to be optimal for factory or field testing motors and generators as well as substation apparatus like switchgear, bus ducts, arrestors or bushings, and shorter MV cable lengths. Other sizes are available on a custom basis. (HVI produces only Parallel Resonant, no Series).

Model	OUTPUT				INPUT				
	Voltage		kVA	Amps	Voltage		kVA	Amps	Freq.
PAR-1680FC5	0 - 16 kVac	@	80 kVA	5 A	230 V	@	10 kVA	45 A	50/60 Hz.
PAR-32/16160FC5	0 - 16/32 kVac	@	160 kVA	5 A	230 V	@	20 kVA	90 A	50/60 Hz
PAR-32250FC5	0 - 32 kVac	@	250 kVA	8 A	230 V	@	20 kVA	90 A	50/60 Hz
PAR-50250FC5	0 - 50 kVac	@	250 kVA	5 A	230 V	@	20 kVA	90 A	50/60 Hz
PAR-100100FC5	0 - 100 kVac	@	100 kVA	1 A	230 V	@	20 kVA	90 A	50/60 Hz

**Size & Weight (approximate)** - All models CE compliant. Custom voltage and power ratings available.

### 10 kVA Input Models

Controller: 21" w x 25.5" d x 31" h, 210 lbs. 53w x 65d x 79h cm, 95 kg  
 HV Tank: 28" w x 28" d x 37" h, 800 lbs. 71w x 71d x 94h cm, 364 kg

### 20 kVA Input Models

Controller: 22" w x 25.5" d x 47.5" h, 310 lbs. 56w x 65d x 121h cm, 141 kg  
 HV Tank: 30" w x 30" d x 52" h, 1100 lbs. 76w x 76d x 132h cm, 499 kg

### Optional Upgrades



#### Flashing Warning Light

Flashing Red Warning Lamp that illuminates when the high voltage circuit has been energized. Available on all control packages.



#### Safety Light Stack

Status light option, illuminates green when the high voltage circuit is not energized and illuminates red when the high voltage circuit is energized. Available on all control packages.



#### Safety Key Interlock Switch

Front panel mounted key operated interlock switch. Available on all control packages.



#### Casters

2 inch or 6 inch casters mounted under the Control and/or High Voltage Section. Available on all control packages.

## High Voltage Section Configurations

The high voltage section of every PAR Parallel Resonant AC Test Set is housed inside of a reinforced steel tank terminated with a phenolic output bushing and shielded EPR cable with stress cones.

A half voltage, full kVA secondary output is optional on many of the PAR Parallel Resonant AC Test Sets. This allows for lower voltage but higher current testing when compared to the full voltage, full kVA output tap. Both output voltage taps will be active at the same time.



## Optional Accessories



### **DVR-150**

The DVR-150 is a precision voltage divider used to verify the voltage calibration of your PAR Parallel Resonant AC Dielectric Test Set.



### **Grounding Sticks**

Safely confirm the device under test has been discharge and is at at ground potential before handling after testing.



### **Hand and Foot Safety Interlock Switches**

Dead man style safety switches that connect to the external interlock provisions on the rear terminal block of the PAR Parallel Resonant AC Dielectric Test set The switch must be depressed before "HV On" and remain depressed during the duration of the testing. Releasing the switch has the same effect as hitting "HV Off", turning off the high voltage circuit. Supplied with 12 foot lead.



# ALT SERIES CONTENTS

Aerial Lift Testing Equipment .....	58
Applications .....	58
Aerial Lift Testing Capabilities .....	59
Other Testing Applications .....	60
How to Size an AC Hipot/Dielectric Test Set .....	60
Controls and Configurations .....	61
ALT Series Specifications .....	63
Optional Upgrades .....	65
AC Output Config. Toroidal Output & DC Output Config. Cable Output ...	66



# AERIAL LIFT TESTING EQUIPMENT

## Applications

### Aerial Lift Testing

High Voltage Inc, is the leading supplier of high voltage test equipment designed to test all insulating components of aerial lifts and trucks. Whether testing with AC or DC voltage, HVI offers the best instruments available for testing booms, liners and insulating fluids.



The test voltages used are dependent on the class of the truck: A, B, or C and are detailed in various testing standards. The most common hipots used are rated 0 - 100 kVdc @ 10 mA for DC testing and 0 - 130kVac for AC testing. A DC hipot with a 5 or 10 mA dc output current rating is adequate for the test. If AC testing, the capacitance of the load, or actual past test data, must be known. AC boom testing usually requires 2 kVA - 3 kVA of power. When testing liners or buckets, the capacitance is higher, requiring an AC test set rated for 8 – 10 kVA of output power. A hipot rated to 50 kVac @ 10 kVA is needed to test liners for factory certification and/or 35 kVac for maintenance testing. Some standards require the hydraulic fluid, or oil to be tested.

## Aerial Lift Testing Capabilities

Our model ALT-130/60 is the most powerful and full-featured AC aerial lift tester on the market. This model can also be used for other AC testing applications like insulators, iso phase bus duct, bushings, hot sticks, rubber products, etc. If DC voltage is to be used, our PTS –100U 100kVDC hipot is available.

Other AC bucket truck testers are either too low in voltage and/or power to perform all the many tests needed. Our unit can do it all. If dielectric testing hydraulic fluid and oil is required, use our DTS Series.

### Our Advantages

- Our duty rating of 7 kVA is higher than most others, permitting the testing of most liners (Consult factory for liner testing applications, like the use of our 50kVac@ 10kVA model)
- 7 kVA for 1 hour on / 2 hours off, and 4 kVA continuous
- 0-60kVAC and 0-130kVAC output taps
- Internal voltmeter divider, not an external divider stick used by others
- 250 uA current meter scale and 1 mA scale with multipliers up to 100x
- Internal inductive compensation to cancel out some of the capacitive reactance of the load, reducing the input power
- Secondary capacitive current cancellation circuit (optional)
- Guard/Ground for increased accuracy of leakage readings
- Ruggedized meters
- Glass front meters eliminate static buildup



## Other Testing Applications

The ALT series is designed for testing resistive and light to medium capacitive loads and engineered to maintain the ideal size and weight for field portability. These units are well suited for pass/fail, AC over-voltage withstand test on electrical apparatus like vacuum bottles, interrupters, switchgear, circuit breakers, reclosers, hotline tools/safety products, short lengths of bus duct, small motors, small transformers, and many other apparatus needing an AC test voltage.



Vacuum Bottles/Interrupters



Switchgear and Circuit Breakers



Substation Apparatus



Hotline Tools



Iso Phase Buss

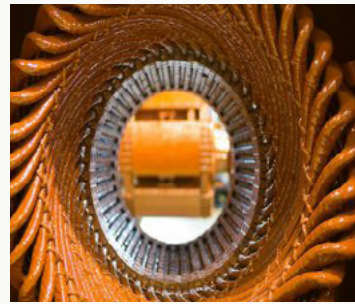

Small Motors/Generators

## Controls and Configuration

ALT-130/60, ALT-130/60F, ALT-210/50, and ALT-210/50F

- Continuously adjustable output voltage
- Secondary connected 3 range analog voltmeter
- 4 range analog current meter
- Guard/ground circuit for accurate leakage current measurement
- Transit protected, glass faced meters to prevent damage in transit
- Fixed overload set to 120% of variable transformer rated output current
- Built in timer function with buzzer alarm
- Zero start safety interlock
- External interlock provisions

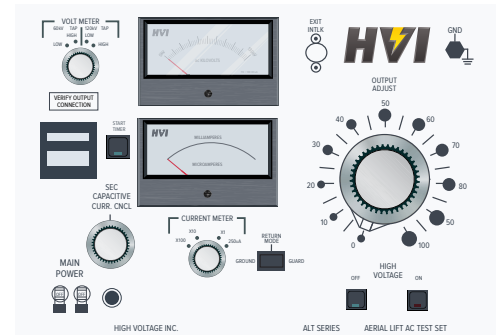

ALT-300F

- Continuously adjustable output voltage
- Secondary connected 2 range analog voltmeter
- 4 range analog current meter
- Guard/ground circuit for accurate leakage current measurement
- Transit protected, glass faced meters to prevent damage in transit
- Fixed overload set to 120% of variable transformer rated output current
- Built in timer function with buzzer alarm
- Zero start safety interlock
- External interlock provisions

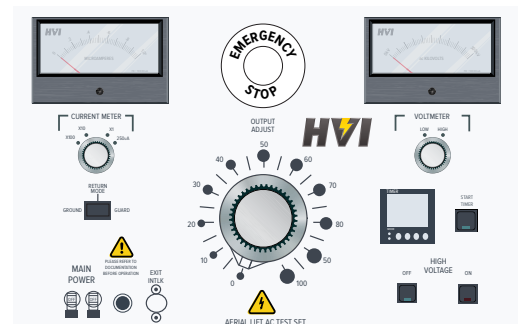

## PTS-100U

- Continuously adjustable output voltage
- Secondary connected 2 range analog voltmeter
- 5 range analog current/Megohm meter
- Megohm readings at any voltage
- Guard/ground circuit for accurate leakage current measurement
- Transit protected, glass faced meters to prevent damage in transit
- Fixed overload factory set to 11mA<sub>dc</sub>
- 50 foot test leads and shielded output cable
- Zero start safety interlock
- External interlock provisions

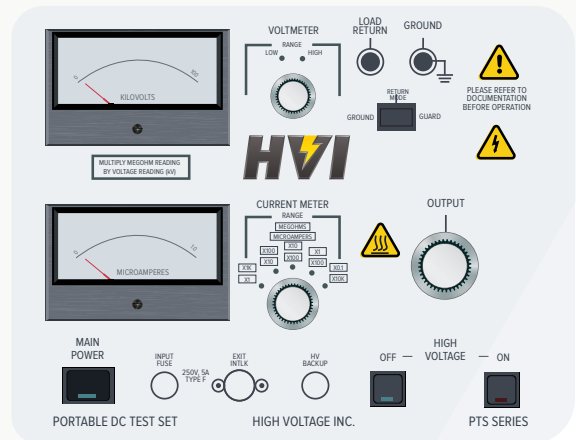

## ALT Series Specifications



ALT-130/60



ALT-210/50

### ALT-130/60

**Input:** 120 V, 60 Hz, 30 A (ALT-130/60)  
230 V, 50/60 Hz, 15 A (ALT-130/60F)

**Output:** 0-130kV AC / 0-60 kV AC, 3.6 kVA resistive load up to 7.2KVA capacitive load (1.3 nF @ 130kV or 5.3nF @ 60kV, 60 Hz)  
Output current is reduced at lower voltages

**Duty:** 7.2 kVA: 1 hour ON, 2 hour OFF  
4 kVA: continuous

**Voltmeter:** 3.5", scaled 0-30/60kV & 0-60/130kV AC,  $\pm 2\%$  F.S.

**Current Meter:** 3.5", scaled 0-250uA and 0-1.0mA  $\pm 2\%$  F.S. with range multipliers of x1, x10, x100

**Distortion:** Less than 5%

**Size & Weight:** Case: 21 x 11.5 x 15.5 in., 46 lb.  
533 x 292 x 394 mm, 21 kg  
HV Tank: 15.5 x 15.5 x 27.5 in., 160 lb.  
394 x 394 x 698.5 mm, 72.5 kg

**Output Termination:** Top Toroid (0-130kV)  
1 inch ball side tap (0-60kV)

**Scope of Supply:** (2) 20ft black ground leads, 20ft shielded return cable, external interlock plug, operations manual, calibration certificate

### ALT-210/50

**Input:** 120 V, 60 Hz, 30 A (ALT-210/50)  
230 V, 50/60 Hz, 15 A (ALT-210/50F)

**Output:** 0-210kV AC / 0-50 kV AC, 3 kVA resistive load up to 7 KVA capacitive load  
Output current is reduced at lower voltages

**Duty:** 7 kVA: 1 hour ON, 2 hour OFF  
4 kVA: continuous

**Voltmeter:** 3.5", scaled 0-20/50, 0-80/210 kV AC (RMS)

**Current Meter:** 3.5", scaled 0-250uA and 0-1.0mA  $\pm 2\%$  F.S. with range multipliers of X1, X10, X100

**Distortion:** Less than 5%

**Size & Weight:** Case: 21 x 11.5 x 15.5 in., 59 lb.  
533 x 292 x 394 mm, 27 kg  
HV Tank: 15.5 x 15.5 x 37.5 in., 240 lb.  
394 x 394 x 953 mm, 109 kg

**Output Termination:** Top toroid (0-210 kV)  
1 inch ball side tap (0-50 kV)

**Scope of Supply:** (2) 20ft black ground leads , 20ft shielded return cable, external interlock plug, operations manual, calibration certificate





ALT-300F



PTS-100U

## ALT-300F

**Input:** 230 V, 50/60 Hz, 30 A

**Output:** 300kV AC, 7kVA resistive load  
7kVA capacitive load  
Output current is reduced at lower voltages

**Duty:** 7kVA: 1 hour ON, 2 hour OFF  
5 kVA: continuous

**Voltmeter:** 3.5", scaled 120/300kV kV AC,  $\pm 2\%$  F.S.

**Current Meter:** 3.5", scaled 0-250uA and 0-1.0mA  $\pm 2\%$  F.S.  
with range multipliers of x1, x10, x100 up to 100 mA

**Distortion (ALT):** Less than 5%  
**Megohmmeter (PTS):**

**Size & Weight:** Case: 21 x 15.5 x 15.5 in., 80 lb.  
534 x 394 x 387 mm, 36 kg  
HV Tank: 28 x 28 x 69 in., 1050 lb.  
712 x 712 x 1753 mm, 476 kg

**Output Termination:** Top Toroid (0-300kV)

**Scope of Supply:** (2) 20 ft black ground leads, 50ft shielded return lead return cable, external interlock plug, operations manual, calibration certificate

## PTS-100U

120 V, 60Hz, 15 A (PTS-100U)  
230 V, 50/60 Hz, 8 A (PTS-100UF)

0 – 100 kV DC @ 10 mA,  
negative polarity, positive ground  
Full Wave Bridge Rectification

Continuous, capacitive charging

3.5", Scaled 0 - 50/100 kV DC,  $\pm 2\%$  F.S.

3.5", scaled 0 – 1.0 uA DC,  $\pm 2\%$  F.S. with multipliers of x 1, x 10, x 100, x 1 k, x 10k Guard/ground load return

N/A capacitive load

**Case:** 14 x 11 x 14 in., 30 lb.  
356 x 279 x 356 mm, 14 kg  
**HV Tank:** 9.5 x 11.75 x 15.5 in., 68 lb.  
241 x 298 x 368 mm, 31 kg

50ft. (15m) shielded EPR output cable with alligator clamp EPR cable stays flexible in cold weather

50ft EPR shielded output cable, 50ft red test lead, x2 50ft black test leads, 14in safety ground stick, external interlock plug, operations manual, calibration certificate

## Optional Upgrades

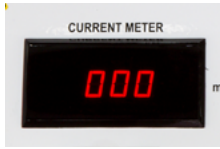

### Digital Metering

Add 3.5-digit digital meters to models with analog meters as standard equipment. Deletes any voltage or current meter range switches.

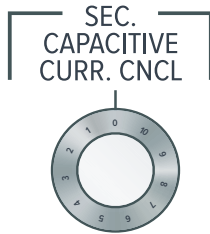

### Secondary Capacitive Current Cancelation Circuit

The SECONDARY CURRENT compensation potentiometer is used to cancel capacitive load currents leaving the resistive component of the signal. To do this, the line signal is sampled and a phase shifted signal is inverted and summed with the load current signal into an OP AMP input. The resulting output, when adjusted to minimum, represents the resistive current in the load. When in the OFF position the capacitive cancel has no effect on the load signal.



### Hand and Foot Safety Interlock Switches

Dead man style safety switches that connect to the external interlock panel socket. The switch must be depressed before "HV On" and remain depressed during the duration of the testing. Releasing the switch has the same effect as hitting "HV Off", turning off the high voltage circuit. Supplied with 12 foot lead.



### Grounding Sticks

Safely confirm the device under test has been discharge and is at ground potential before handling after testing.





## Handcart

Included handcart for increased portability of ALT-130/60 and ALT-130/60F.  
Not available for ALT-210/50F, and ALT-300F.

## AC Output Configuration Toroidal Output and DC Output Configuration Cable Output



## Cable Output

50 foot shielded output cable standard on PTS-100U.



## Toroidal Output

Toroidal dish and/or ball termination on top of a fiberglass cylinder, standard on the ALT-130/60, ALT-130/60F, ALT-210/50, ALT-210/50F, and ALT-300F.

HVI does not supply an output cable on AC test sets 65kVac and above. This includes models that use a metal sphere, spinning, toroid, or bushing as the high voltage output termination. A shielded cable rated for the test voltage is not practical due to the size, weight, and/or high capacitance value. Use of a bare wire, test lead, or tubing is recommended instead. This output connection must be isolated from ground for the test voltage applied. The height of the high voltage section or output bushing are a good reference for the clearance needed. Refer to the manual for your exact equipment for more information. It is up to the user to ensure a safe and effective test setup.

# ABT SERIES CONTENTS

Benchtop Power Frequency AC Hipot Test Sets .....	68
Applications .....	68
Configurations and Controls .....	71
Optional Upgrades .....	73
High Voltage Section Configurations .....	74
Matrix of Model/Specs .....	75
Optional Accessories .....	77

# BENCHTOP POWER FREQUENCY AC HIPOT TEST SETS

The ABT Series from HVI are benchtop power frequency AC hipot test sets designed around the industry leading PFT series of portable AC hipots, for a variety of factory, laboratory, and repair shop testing applications. With a variety of control options, the ABT series are custom built in the USA at our factory in upstate New York. Models range from 10kV to 50kV at 1.5kVA of output power. All are equipped with transit protected and anti-static glass faced meters, a guard circuit, and an adjustable overload as standard equipment.

## Applications

The ABT series were designed for testing resistive or light capacitive loads in a shop or factory and are well suited for pass/fail, AC over-voltage withstand test on high voltage apparatus like vacuum bottles, interrupters, switchgear, circuit breakers, reclosers, hotline tools/safety products, short lengths of bus duct, small motors, small transformers, electrical components, and many other apparatus needing an AC test voltage.



Vacuum Bottles/Interrupters



Switchgear and Circuit Breakers



Substation Apparatus



Hotline Tools

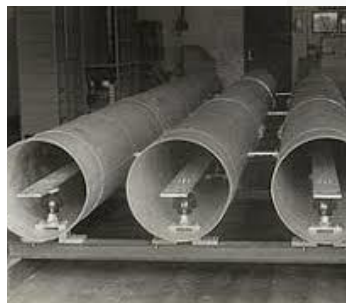

Iso Phase Buss

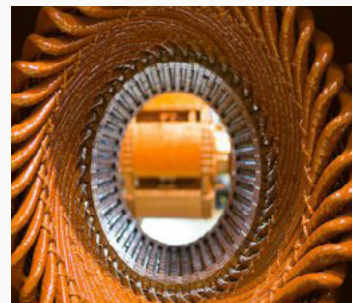

Small Motors/Generators

## How to Size an AC Dielectric Test Set

When AC testing, most loads appear capacitive. To apply high voltage AC at power frequency (50/60Hz) to a capacitive load requires higher power and current ratings from the test set when compared to DC. Unlike DC where the capacitance of the load only needs to be overcome once, as you slowly raise the output voltage, AC must overcome the capacitance 2 times per cycle. Once while reaching the peak voltage on the positive side of the sinewave and the second while reaching the peak voltage on the negative side of the sinewave after crossing the zero reference. The output power or kVA requirement may be very different depending on the load of the apparatus under test. The capacitance of the load must be known to calculate the required current at the specified test voltage. Don't undersize the set, select a test set with at least 25% extra power than needed.



## Don't Undersize the Set

AC high voltage testing requires higher power and current ratings when compared to DC testing the same test object. There are several parameters that must be considered when selecting an AC hipot or dielectric test set, the most important one being the capacitance of the load. This capacitance dictates the amount of output power, or the relationship of the amount of current drawn by the device under test to the specified test voltage required from the test set. Following are several considerations when specifying a test set.



## Voltage Output

Select a test set with 20 – 25% more voltage than your requirement for enough voltage headroom to compensate for any possible future changes in testing standards or the testing application. The output current of the test set is based on the kVA, or Power rating at full voltage. Any increase in the output voltage rating for the same kVA rated test set will proportionately decrease the current rating.

## Power/Current Rating

Power rating, or kVA is calculated by multiplying the maximum output voltage by the maximum output current. When AC testing, most loads appear capacitive. To apply high voltage AC at power frequency, 50 or 60 Hz to a capacitive load requires higher power and current ratings from the test set than most portable AC hipots can typically supply. The capacitance of the load must be known in order to calculate the required current at the desired test voltage. Select a test set, with at least 20 - 25% extra power than



believed needed. To determine the current needed from the test set, the following formula should be used: Another way to determine the current needed at the required test voltage is to apply a lower voltage to the load and measure the current. The current draw of the device under test at the actual higher test voltage should be a linear increase. For example, if your test load draws 1mA @ 5 kV it will draw approximately 10 mA @ 50 kV. An AC test set is a constant current device, the maximum output current is the same at any output voltage. For higher current requirements please see our FPA Series, HPA series, and PAR series.

$$A = 2\pi fCV$$

**A = Test current required in Amps (A)**

**f = Test frequency in Hertz (Hz)**

**C = Load capacitance in Farads (F)**

**V = Test voltage in volts (V)**

## Duty Cycle

Most AC dielectric strength testing is short duration testing performed for 60 seconds at a time, however, production testing may require consecutive tests over many hours. Most ABT AC test sets are rated for 50% duty. The full power rating can be delivered for one hour on followed by one hour off. Most ABT AC test sets are rated for continuous duty at approximately 80% of the full power rating.

## Partial Discharge Requirements

The ABT Series AC test sets are not PD rated.

# Controls and Configurations

## Standard Controls: Simplifies controls with manual output voltage

- Voltage meter: two range
- Current meter: three range
- Main Power breaker/indicating light
- HV On/Off
- Output Adjust control knob
- Variable Overload w/reset, 10-110% of rated output current
- External interlock provisions

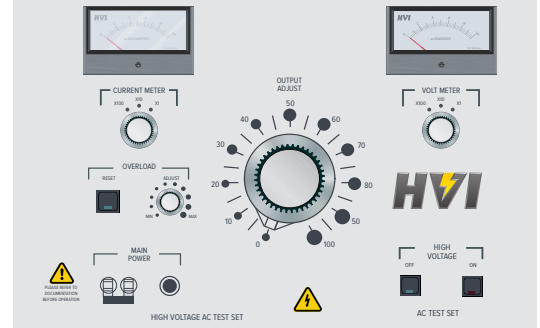

## C2 Controls: Simplified Controls with motorized output voltage control

- Voltage meter: two range
- Current meter: three range
- Guard/Ground Circuit
- Control Power breaker/indicating light
- HV On/Off
- Voltage Raise/Lower control
- Fixed voltage rate-of-rise
- Variable Overload w/reset, 10-110% of rated output current
- Emergency Off button
- External interlock provisions

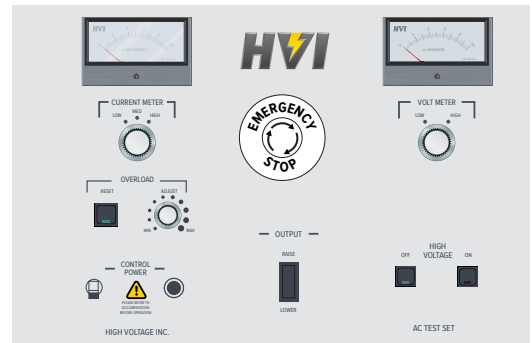

## C3 Controls: Automatic Controls with 3.5 Digit Digital Metering

- Voltage meter: digital 3.5 digits
- Current meter: digital 3.5 digits
- Guard/Ground Circuit
- Control Power breaker
- HV On/Off
- Output Mode: Manual/Auto
- Output Voltage: Raise/Lower control Four fixed volts/second rates-of-rise 10 – 100 seconds, consult factory
- Test Dwell timer
- Variable Overload w/reset, 10-110% of rated output current
- Emergency Off button
- External interlock provisions

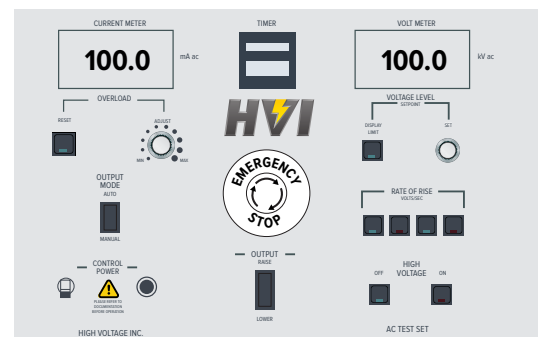

#### C4 Controls: Automatic Controls with 4.5 Digit Digital Metering

- Voltage meter: digital 4.5 digits
- Current meter: digital 4.5 digits
- Guard/Ground Circuit
- Control Power breaker
- HV On/Off
- Output Mode: Manual/Auto
- Output Voltage: Raise/Lower control Four fixed volts/second rates-of-rise 10 – 100 seconds, consult factory
- Test Dwell timer
- Variable Overload w/reset, 10-110% of rated output current
- Emergency Off button
- External interlock provisions

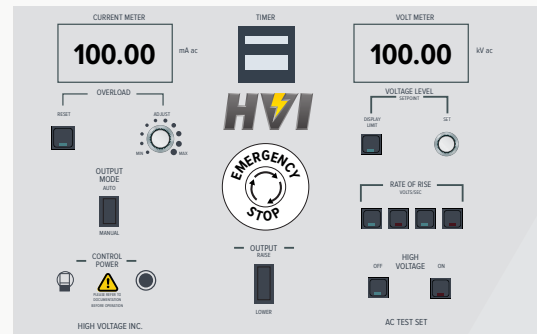

#### C5 Controls - PLC programmed and controlled – any kVA

The C5 PLC controller provides an on-board PLC for complete operational and programming control and includes a PC interface to download tests results for report generation. The PLC can fully automate repetitive testing in automatic mode or perform simple hipot tests in manual mode. Test profiles for automatic mode can be preset at the factory or can be entered via the touch screen control. Operation is easily modified using Ladder Logic Programming. The C5 controller allows the user to fully program the operation of the set from the PLC and allows complete downloading of test results for report generation using your reporting software. Guard/Ground Circuit not available with C5 controller.

- 320 x 240 color touch screen display for programming and operation
- Graphical display of output voltage and current during test
- Output voltage and current final test results displayed
- PC Interface for data download via RS-232
- Save and recall test profiles easily
- External interlock provisions User Selectable/Settable Parameters:
- Automatic or Manual Mode
- Voltage set point
- Over Current set point
- Test Dwell Timer
- Voltage Rate of Rise (10-100 Seconds)

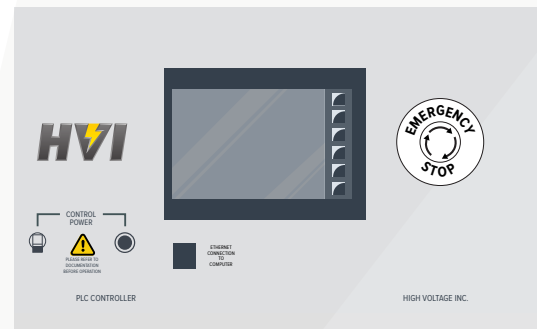



## Optional Upgrades

### PLC Interface

A C3 or C4 controller that also offers input and output control provisions to interface with a remote programmable logic controller (PLC) or some other customer supplied controller. It can be operated in the Local mode using the front panel controls or in the Remote mode via customer supplied external controls. Includes 0-10Vdc Input Control and Output Feedback signals, permitting the remote control over the dielectric test set for most functions with output signals to communicate to an external customer supplied PLC controller. When in the REMOTE mode, all front panel controls are disengaged except for the Emergency Off, Voltmeter and Current meter. Available only on the C3 and C4 control packages.

#### Input Remote Control Signals

- Contact N/O: Close HV ON - Open HV OFF
- Rate of Rise: 0-10V = 10s – 100s to full output
- Contact N/O: RAISE – Close to operate
- Contact N/O: LOWER – Close to operate
- Contact N/C: Overload Reset – Open to operate
- Overload Set Point: 0-10Vdc = 10 - 110% current

#### Output Feedback Signals

- Remote Enabled: N/O
- Main Power ON: N/O
- High Voltage ON: N/O
- Overload FAULT: N/O
- Voltage: 0-10Vdc = 0 - 100% output voltage
- Current: 0-10Vdc = 0 - 100% output current
- Voltage return to 0 (automatic after overload): N/O

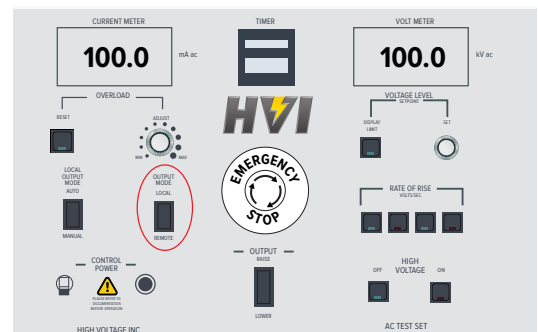

### BURN Circuit

An optional BURN reactor provides the ability to enable current limiting of the output for burning a fault within the device under test in order to locate it. The OVERLOAD function is disabled when BURN is ON. Available on all control packages.



### Flashing Warning Light

Flashing Red Warning Lamp that illuminates when the high voltage circuit has been energized. Available on all control packages.





## Safety Light Stack

Status light option, illuminates green when the high voltage circuit is not energized and illuminates red when the high voltage circuit is energized. Available on all control packages.



## Safety Key Interlock Switch

Front panel mounted key operated interlock switch. Available on all control packages.



## Casters

2 inch or 6 inch casters mounted under the Control and/or High Voltage Section. Available on all control packages.

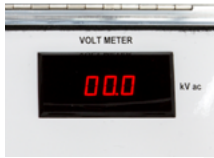

## Digital Meters

3.5 digit digital meter upgrade. Available as an upgrade to C1 (standard controller package) and C2 style control packages. Adds "D" suffix to model number.

## High Voltage Section Configurations



## Cable Output

Terminated with a shielded output cable.

## Matrix of Models/Specs



Shown with digital meter upgrade



Shown with C3 Controller

### ABT-103CM

**Input:** 120 V, 60Hz, 15 A (ABT-103CM)  
230 V, 50/60Hz, 8 A (ABT-103CMF)

**Output:** 0-10 kV AC, 1.5 kVA  
Up to 150 mA current  
Output current is reduced at lower voltages

**Duty:** 1.5 kVA: continuous

**Voltmeter:** 3.5", scaled 0-5/10 kV AC,  $\pm 2\%$  F.S.

**Current Meter:** 3.5", scaled 0-5/10 kV AC,  $\pm 2\%$  F.S.  
with range multipliers of x1, x10, x100,  
guard/grounded load return

**Distortion:** Less than 5%

**Size & Weight:** 21 x 15.5 x 14.5 in., 70 lb  
533 x 394 x 368mm, 32kg

**Output Termination:** 20 ft. (6m) shielded EPR output  
cable with alligator clamp

**Scope of Supply:** 20ft black ground lead, operation  
manual, calibration certificate

### ABT-303CM

120 V, 60 Hz, 15 A (ABT-303CM)  
230 V, 50/60 Hz, 8 A (PABT-303CMF)

0-30 kV AC, 1.5 kVA  
Up to 50 mA current  
Output current is reduced at lower voltages

1.5 kVA: continuous

3.5", scaled 0-12/00 kV AC,  $\pm 2\%$  F.S.

3.5", scaled 0-5/10 kV AC,  $\pm 2\%$  F.S.  
with range multipliers of x1, x10, x100,  
guard/grounded load return

Less than 5%

21 x 15.5 x 14.5 in., 104 lb  
533 x 394 x 368mm, 47kg

20 ft. (6 m) shielded output cable  
with alligator clamp

20ft black ground lead, operation  
manual, calibration certificate



## ABT-503CM

**Input:** 120 V, 60 Hz, 15 A (ABT-503CM)  
230 V, 50/60 Hz, 8 A (ABT-503CM)

**Output:** 0-10 kV AC, 1.5 kVA  
Up to 30 mA current  
Output current is reduced at lower voltages

**Duty:** 1.5 kVA: continuous

**Voltmeter:** 3.5", scaled 0-25/50 kV AC,  $\pm 2\%$  F.S

**Current Meter:** 3.5", scaled 0-1.0 mA,  $\pm 2\%$  F.S. with range multipliers of x1, x10, x100, guard/grounded load return

**Distortion:** Less than 5%

**Size & Weight:** 21 x 15.5 x 14.5 in., 104 lb.  
533 x 394 x 368mm, 47kg

**Output Termination:** 20 ft (6m) shielded output cable with alligator clamp

**Scope of Supply:** 20ft black ground lead, operation manual, calibration certificate

## Optional Accessories



### **DVR Series**

The DVR-150 and DVR-300 are precision voltage dividers used to verify the voltage calibration of your ABT AC Hipot Test Set.



### **Grounding Sticks**

Safely confirm the device under test has been discharge and is at ground potential before handling after testing.



### **Hand and Foot Safety Interlock Switches**

Dead man style safety switches that connect to the external interlock provisions on the rear terminal block of the ABT AC Hipot Test Set.

The switch must be depressed before "HV On" and remain depressed during the duration of the testing. Releasing the switch has the same effect as hitting "HV Off", turning off the high voltage circuit. Supplied with 12 foot lead.



# PTS SERIES CONTENTS

Portable DC Hipot Test Sets for Field and Factory Use .....	80
Applications .....	80
PTS Series Advantages .....	81
PTS-75 & PTS-80 Differences .....	81
High Voltage Configurations .....	82
Controls and Configurations .....	82
PTS Series Specifications .....	83
Optional Accessories .....	88
Optional Upgrades .....	88

# PORTABLE DC HIPOT TEST SETS FOR FIELD AND FACTORY USE

The PTS series of DC hipot test sets was designed to be the most functional and versatile portable hipots we could manufacture. The PTS series hipots are roughly the same size and weight or smaller than the competition but offer far more features and functionality. Our DC hipots up to 130 kV are rated for 10 mA units from 200 kVDC - 600 kVDC are rated for 5 mA. Hipots up to 75 kVDC contain a +/- 1% line voltage regulator built in to stabilize the incoming power source, resulting in more stable and accurate leakage current readings. All PTS units have a built in high voltage megohmmeter enabling the same instrument to be used for insulation resistance testing. Our meters use 100 uA meter movements, with digital meters as an available ordering option. The meters are also transit-protected, reducing the risk of breakage during transportation.

## Applications

The PTS series are designed for field, shop or factory testing of shielded power cables, switchgear, wire harnesses, motors, generators, hotline tools/safety products, aerial lifts/bucket trucks and substation apparatus. The PTS series is ideal for any DC over voltage withstand test. The guard-ground circuit allows for precise leakage current measurement. The built in megohmmeter scale inverse to the current meter scale allows for accurate insulation resistance measurements able to be taken at any voltage.

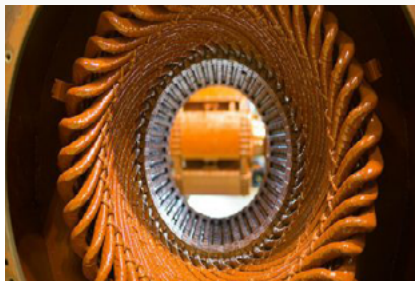

Motors and Generators



Aerial Lifts & Bucket Trucks



Substation Apparatus



Hotline Tools

## PTS Series Advantages

High Voltage, Inc. produces the top DC Hipots available. Our standard models range from 37.5 kVDC to 600 kVDC. The PTS series hipots are roughly the same size and weight or smaller than the competition but offer far more features and functionality. Our DC hipots, up to 130 kV, are rated for 10 mA, not 5 mA. Models up to 75 kVdc contain a +/- 1% line voltage regulator built in to stabilize the incoming power source, resulting in more stable and accurate leakage current readings. All PTS units have a built in high voltage megohmmeter enabling the same instrument to be used for insulation resistance testing. Our meters use 100 uA meter movements, rather than the 5 or 10 uA of others on the market. This makes our meters much more durable. We have transit-protected meters, reducing the breakage from rough handling during transit.

Standard features and benefits:

- Secondary Connected 2 Range Voltmeter
- 5 Range Current/Megohmmeter
- Megohm readings taken at any voltage
- 3.5 Digit Digital Meters Optional
- Factory Fixed Overcurrent Overload
- Guard/Ground Circuit for Accurate Current Measurement
- Anti-static Glass Faced Volt and Current Meters
- Transit Protected Volt and Current Meters
- Full-wave Bridge Rectifier
- External Safety Interlock Provisions
- Zero Start Safety Interlock
- Under Lid and/or HV Tank Mounted Storage for All Accessories

## PTS-75 & PTS-80 Differences

The PTS-75 and the PTS-80 are very similar. The PTS-75 offers a 75kVdc output while the PTS-80 provides 80kVdc. All other specifications and features are the same except for one important difference. The PTS-75 contains a +/- 1% input voltage regulator circuit designed to stabilize the incoming voltage powering the instrument. This enables the user to make more precise and stable leakage current readings, as the output voltage and current, does not fluctuate as much as it would without this circuit. The PTS-80 does not have this circuit. The regulating circuit is a ferro-resonant transformer/capacitor circuit. It is sensitive to frequency fluctuations and the input waveform. It works extremely well when the hipot is powered from utility power or a “sine wave” output inverter. It may not work properly if powered from a poorly regulated output from a motor generator or an inverter with a “modified sine wave” output, which is really a chopped square wave. If you only have available an inverter that is not a “true sine wave” design, then buy the PTS-80.

**PTS-75** - Utility, stable generator, or true sine wave inverter power source

**PTS-80** - Any input power source, including “modified sine wave” inverter



## High Voltage Section Configurations



### Cable Output

Shielded output cable terminated with a red booted alligator clip is standard on PTS-15, PTS-37.5, PTS-75, PTS-80, PTS-100, PTS-130, and PTS-200.



### Toroidal Output

Aluminum Toroid is standard on the PTS-300 and PTS-600BT. External Current Limit Resistors are provided. No output cable provided.

## Controls and Configuration

PTS-15, PTS-37.5, PTS-75, PTS-80, PTS-100, and PTS-130

- Continuously adjustable output voltage
- Secondary connected 2 range analog voltmeter
- 5 range analog current/megohmmeter
- Guard/ground circuit for accurate leakage current measurement
- Transit protected, glass faced meters to prevent damage
- Fixed overload set to 11mA current
- Zero start safety interlock
- External interlock provisions

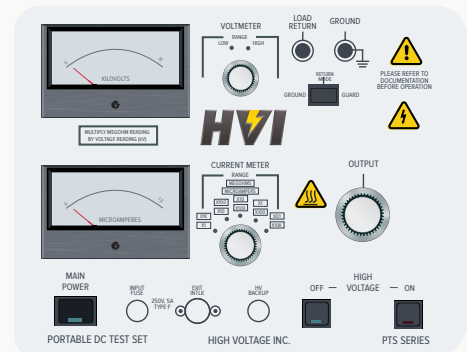

PTS-200, PTS-300 and PTS-600BT

- Continuously adjustable output voltage
- Secondary connected 2 range analog voltmeter
- 5 range analog current/megohmmeter
- Guard/ground circuit for accurate leakage current measurement
- Transit protected, glass faced meters to prevent damage
- Fixed overload set to 6mA current
- Zero start safety interlock
- External interlock provisions

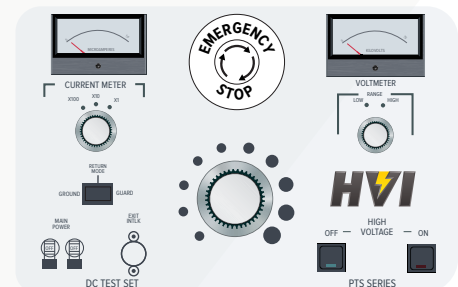

## PTS Series Specifications



PTS-15



PTS-37.5

### PTS-15

**Input:** 120Vac, 60Hz, 10A (PTS-15)  
230Vac, 50Hz, 5A (PTS-15F5)  
230Vac, 60Hz, 5A (PTS-15F6)  
+/-1% input voltage regulator

**Output:** 0 – 15 kV DC @ 10 mA, negative polarity,  
positive ground  
Full Wave Bridge Rectification

**Duty:** Continuous, capacitive charging

**Voltmeter:** 3.5", scaled 0 – 7.5/15 kV DC,  $\pm 2\%$  F.S.

**Current Meter:** 3.5", scaled 0 – 1.0  $\mu$ Adc,  $\pm 2\%$  F.S. with  
multipliers of x 1, x 10, x 100, x 1 k, x 10 k.  
Guard/ground load return

**Megohmmeter:** Scaled 100 -1 M $\Omega$   $\pm 2\%$  F.S. with multipliers  
of x 0.1, x 1, x 10, x 100, x 1 k

**Size & Weight:** 14 x 11 x 14 in., 55 lb.  
356 x 279 x 356 mm, 25 kg

**Output Termination:** 20 ft. (6 m) shielded output cable with alligator clamp

**Scope of Supply:** 20ft red test lead, 20ft black test leads,  
10in safety ground stick, external interlock plug,  
operations manual, calibration certificate

### PTS-37.5

120Vac, 60Hz, 10A (PTS-37.5)  
230Vac, 50Hz, 5A (PTS-37.5F5)  
230Vac, 60Hz, 5A (PTS-37.5F6)  
+/-1% input voltage regulator

0 – 37.5 kV DC @ 10 mA, negative polarity,  
positive ground  
Full Wave Bridge Rectification

Continuous, capacitive charging

3.5", scaled 0 – 15/37.5 kV DC,  $\pm 2\%$  F.S.

3.5", scaled 0 – 1.0  $\mu$ Adc,  $\pm 2\%$  F.S. with  
multipliers of x 1, x 10, x 100, x 1 k, x 10 k.  
Guard/ground load return

Scaled 100 -1 M $\Omega$   $\pm 2\%$  F.S. with multipliers  
of x 0.1, x 1, x 10, x 100, x 1 k

14 x 11 x 14 in., 61 lb.  
356 x 279 x 356 mm, 28 kg

20 ft. (6 m) shielded output cable with alligator clamp

20ft red test lead, 20ft black test leads,  
10in safety ground stick, external interlock plug,  
operations manual, calibration certificate



PTS-75



PTS-80

## PTS-75

**Input:** 120Vac, 60Hz, 10A (PTS-75)  
 230Vac, 50Hz, 5A (PTS-75F5)  
 230Vac, 60Hz, 5A (PTS-75F6)  
 +/-1% input voltage regulator

**Output:** 0 – 75 kV DC @ 10 mA, negative polarity,  
 positive ground  
 Full Wave Bridge Rectification

**Duty:** Continuous, capacitive charging

**Voltmeter:** 3.5", scaled 0 – 37.5/75 kV DC, ±2% F.S.

**Current Meter:** 3.5", scaled 0 – 1.0 μA<sub>dc</sub>, ±2% F.S. with  
 multipliers of x 1, x 10, x 100, x 1 k, x 10 k.  
 Guard/ground load return

**Megohmmeter:** Scaled 100 -1 MΩ ±2% F.S. with multipliers  
 of x 0.1, x 1, x 10, x 100, x 1 k

**Size & Weight:** 14 x 11 x 18 in., 68 lb.  
 356 x 279 x 457 mm, 31 kg

**Output Termination:** 20 ft. (6 m) shielded output cable with alligator clamp

**Scope of Supply:** 20ft red test lead, 20ft black test leads,  
 10in safety ground stick, external interlock plug,  
 operations manual, calibration certificate

## PTS-80

120Vac, 60Hz, 10A (PTS-80)  
 230Vac, 50/60Hz, 5A (PTS-80F)

0 – 80 kV DC @ 10 mA, negative polarity,  
 positive ground  
 Full Wave Bridge Rectification

Continuous, capacitive charging

3.5", scaled 0 – 40/80 kV DC, ±2% F.S.

3.5", scaled 0 – 1.0 μA<sub>dc</sub>, ±2% F.S. with  
 multipliers of x 1, x 10, x 100, x 1 k, x 10 k.  
 Guard/ground load return

Scaled 100 -1 MΩ ±2% F.S. with multipliers  
 of x 0.1, x 1, x 10, x 100, x 1 k

14 x 11 x 18 in., 65 lb.  
 356 x 279 x 457 mm, 29 kg

20 ft. (6 m) shielded output cable with alligator clamp

20ft red test lead, 20ft black test leads,  
 10in safety ground stick, external interlock plug,  
 operations manual, calibration certificate

## PTS Series Specifications



PTS-100



PTS-100U

### PTS-100

**Input:** 120Vac, 50/60Hz, 15A (PTS-100)  
230Vac, 50/60Hz, 8A (PTS-100F)

**Output:** 0 – 100 kV DC @ 10 mA, negative polarity,  
positive ground  
Full Wave Bridge Rectification

**Duty:** Continuous, capacitive charging

**Voltmeter:** 3.5", scaled 0 – 50/100 kV DC,  $\pm 2\%$  F.S.

**Current Meter:** 3.5", scaled 0 – 1.0  $\mu$ A dc,  $\pm 2\%$  F.S. with  
multipliers of x 1, x 10, x 100, x 1 k, x 10 k.  
Guard/ground load return

**Megohmmeter:** Scaled 100 -1 M $\Omega$  with multipliers  
of x 0.1, x 1, x 10, x 100, x 1 k

**Size & Weight:** Case: 14 x 11 x 14 in., 30 lb.  
356 x 279 x 356 mm, 14 kg  
HV Tank: 9.5 x 11.75 x 14.5 in., 68lb.  
241 x 298 x 368 mm, 31 kg

**Output Termination:** 20 ft. (6m) shielded EPR output cable with  
alligator clamp EPR cable stays flexible in  
cold weather

**Scope of Supply:** 20ft EPR shielded output cable, 20ft red  
test lead, x2 20ft black test leads, 14in  
safety ground stick, external interlock plug,  
operations manual, calibration certificate

### PTS-100U

120Vac, 50/60Hz, 15A (PTS-100U)  
230Vac, 50/60Hz, 8A (PTS-100UF)

0 – 100 kV DC @ 10 mA, negative polarity,  
positive ground  
Full Wave Bridge Rectification

Continuous, capacitive charging

3.5", Scaled 0 - 50/100 kV DC,  $\pm 2\%$  F.S.

3.5", scaled 0 – 1.0  $\mu$ A DC,  $\pm 2\%$  F.S. with  
multipliers of x 1, x 10, x 100, x 1 k, x 10k  
Guard/ground load return

Scaled 100 -1 M $\Omega$  with multipliers  
of x 0.1, x 1, x 10, x 100, x 1 k

Case: 14 x 11 x 14 in., 30 lb.  
356 x 279 x 356 mm, 14 kg  
HV Tank: 9.5 x 11.75 x 14.5 in., 68 lb.  
241 x 298 x 368 mm, 31 kg

50ft. (15m) shielded EPR output cable with  
alligator clamp EPR cable stays flexible in  
cold weather

50ft EPR shielded output cable, 50ft red  
test lead, x2 50ft black test leads, 14in  
safety ground stick, external interlock plug,  
operations manual, calibration certificate



PTS-130



PTS-200

## PTS-130

**Input:** 120Vac, 50/60Hz, 15A (PTS-130)  
230Vac, 50/60Hz, 8A (PTS-130F)

**Output:** 0 – 130 kV DC @ 10 mA, negative polarity,  
positive ground  
Full Wave Bridge Rectification

**Duty:** Continuous, capacitive charging

**Voltmeter:** 3.5", scaled 0 – 75/150 kV DC, ±2% F.S.

**Current Meter:** 3.5", scaled 0 – 1.0  $\mu$ Adc, ±2% F.S. with  
multipliers of x 1, x 10, x 100, x 1 k, x 10 k.  
Guard/ground load return

**Megohmmeter:** Scaled 100 -1 M $\Omega$  ±2% F.S. with multipliers  
of x 0.1, x 1, x 10, x 100, x 1 k

**Size & Weight:** Case: 14 x 11 x 14 in., 34 lb.  
356 x 279 x 356 mm, 15 kg  
HV Tank: 12.25 x 12 x 18 in., 87lb.  
311 x 305 x 457 mm, 39 kg

**Output Termination:** 20ft. (6m) shielded EPR output cable with  
alligator clamp EPR cable stays flexible in  
cold weather

**Scope of Supply:** 20ft EPR shielded output cable, 20ft red  
test lead, x2 20ft black test leads, 14in  
safety ground stick, external interlock plug,  
operations manual, calibration certificate

## PTS-200

120Vac, 50/60Hz, 15A (PTS-200)  
230Vac, 50/60Hz, 8A (PTS-200F)

0 – 200 kV DC @ 5 mA, negative polarity,  
positive ground  
Full Wave Bridge Rectification

Continuous, capacitive charging

3.5", scaled 0 – 80/200 kV DC, ±2% F.S

3.5", scaled 0 – 1.0  $\mu$ Adc, ±2% F.S. with  
multipliers of x 1, x 10, x 100, x 1 k, x 10 k.  
Guard/ground load return

Scaled 100 -1 M $\Omega$  ±2% F.S. with multipliers  
of x 0.1, x 1, x 10, x 100, x 1 k

Case: 14 x 11 x 14 in., 34 lb.  
356 x 279 x 356 mm, 15 kg  
HV Tank: 13 x 14 x 27.5 in., 150 lb.  
330 x 356 x 699 mm, 68 kg

20 ft. (6m) shielded EPR output cable with  
alligator clamp EPR cable stays flexible in  
cold weather

20ft EPR shielded output cable, 20ft red  
test lead, x2 20ft black test leads, 14in  
safety ground stick, external interlock plug,  
operations manual, calibration certificate

## PTS Series Specifications



PTS-300



PTS-600BT

### PTS-300

**Input:** 120Vac, 50/60Hz, 15A (PTS-300)  
230Vac, 50/60Hz, 8A (PTS-300F)

**Output:** 0 – 300 kV DC @ 5 mA, negative polarity,  
positive ground  
Full Wave Bridge Rectification

**Duty:** Continuous, capacitive charging

**Voltmeter:** 3.5", scaled 0 – 120/300 kV DC, ±2% F.S.

**Current Meter:** 3.5", scaled 0 – 1.0  $\mu$ A<sub>dc</sub>, ±2% F.S. with  
multipliers of x 1, x 10, x 100, x 1 k, x 10 k.  
Guard/ground load return

**Megohmmeter:** Scaled 100 -1 M $\Omega$  ±2% F.S. with multipliers  
of x 0.1, x 1, x 10, x 100, x 1 k

**Size & Weight:** Case: 14 x 11 x 14 in., 34 lb.  
356 x 279 x 356 mm, 15 kg  
HV Tank: 36 x 36 x 43.5 in., 380 lb.  
915 x 915 x 1105 mm, 172 kg

**Output Termination:** Top toroid

**Scope of Supply:** 20ft red test lead, x2 20ft black test leads,  
x2 20kohm external limit resistors, 14in  
safety ground stick, external interlock plug,  
operations manual, calibration certificate

### PTS-600BT

120Vac, 50/60Hz, 30A (PTS-600)  
230Vac, 50/60Hz, 15A (PTS-600F)

0 - 600kV DC @ 5 mA Bench top controller,  
negative polarity, positive ground  
Full Wave Bridge Rectification

Continuous, capacitive charging

3.5", scaled 0-300/600 kV DC ±2% F.S

3.5", scaled 0-1.0  $\mu$ A DC, ±2% F.S. with  
multipliers of x 1, x 10, x 100, x 1 k, x 10 k  
Guard/ground load return

100 – 1 M $\Omega$  w/x.1, x1, x10, x100, x1k ranges,  
w/analog meters

Case: 21 x 15.5 x 15 in., 70 lb.  
535 x 395 x 382 mm, 32 kg  
HV Tank: 36 x 15 x 89 in., 580 lb.  
914 x 381 x 1105 mm, 263 kg

Top toroid

20ft red test lead, x2 20ft black test leads,  
x4 20kohm external limit resistors, 14in  
safety ground stick, external interlock plug,  
operations manual, calibration certificate

## Optional Accessories

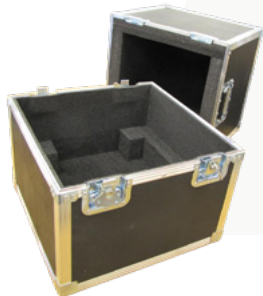

### Hand and Foot Safety Interlock Switches

Dead man style safety switches that connect to the external interlock provisions on the front panel of the PTS DC Hipot test set. The switch must be depressed before "HV On" and remain depressed during the duration of the testing. Releasing the switch has the same effect as hitting "HV Off", turning off the high voltage circuit. Supplied with 12 foot lead.

### Grounding Sticks

Safely confirm the device under test has been discharge and is at ground potential before handling after testing.

### Reusable Shipping Cases

Reusable hard shipping cases designed for safe transportation of your PTS Series DC Hipot.

## Optional Upgrades



### Digital Metering

Add 3.5-digit digital meters to models with analog meters as standard equipment. Deletes or modifies any volt or current meter range switches.

# DBT SERIES CONTENTS

Benchtop DC Hipot Test Sets .....	90
Configurations and Controls .....	91
Optional Upgrades .....	92
Matrix of Model/Specs .....	93



# BENCHTOP DC HIPOT TEST SETS

The DBT Series of DC Hipots are ideal for testing many types of medium and high voltage electrical components and apparatus requiring a DC Withstand test, a DC current leakage measurement, or any DC hipot test. They are designed within benchtop cabinets for the industrial and commercial markets. HVI also offers field portable DC units, our PTS Series, for testing many types of electrical apparatus in the field.

Standard models are available from 15 kVdc - 80kVdc, with current ratings of 10 mAdc. They are all single piece designs with the high voltage section inside the cabinet with a shielded cable for high voltage output. Higher voltage models up to 600 kVdc are available that are two piece designs: controller and HV tank. Various control packages are available, from simple manual controls to fully programmable and computer interfaced controls. They are all built to be durable and reliable, with enhanced design features not found elsewhere.



Vacuum Bottles/Interrupters



Switchgear and Circuit Breakers



Substation Apparatus



Hotline Tools

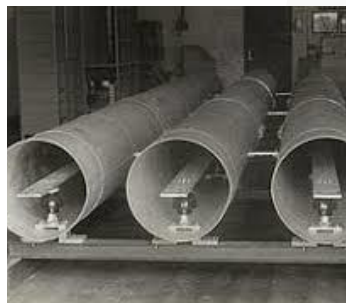

Iso Phase Buss

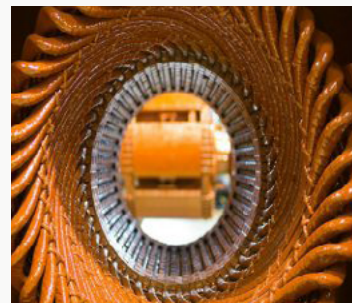

Small Motors/Generators

## High Voltage Section Configurations



### Cable Output

Shielded output cable terminated with a red boot and alligator clip. Standard on DBT-15, DBT-37.5, DBT-75, DBT-80, DBT-100, DBT-130, and DBT-200. No PD spec.



### Toroidal Output

Ring Toroid. Standard on the DBT-300 and PTS-600BT. External Current Limit Resistors are provided. No output cable provided. No PD spec.

## Controls and Configuration

DBT-15, DBT-37.5, DBT-75, DBT-80, DBT-100, and DBT-130

- Continuously adjustable output voltage
- Secondary connected 2 range analog voltmeter
- 5 range analog current/megohmmeter
- Guard/ground circuit for accurate leakage current measurement
- Transit protected, glass faced meters to prevent damage
- Fixed overload set to 11mA current
- Zero start safety interlock
- External interlock provisions

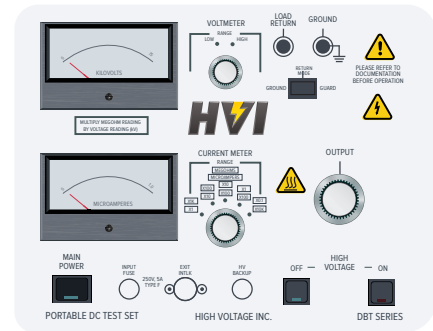

DBT-200, DBT-300 and PTS-600BT

- Continuously adjustable output voltage
- Secondary connected 2 range analog voltmeter
- 5 range analog current/megohmmeter
- Guard/ground circuit for accurate leakage current measurement
- Transit protected, glass faced meters to prevent damage
- Fixed overload set to 6mA current
- Zero start safety interlock
- External interlock provisions

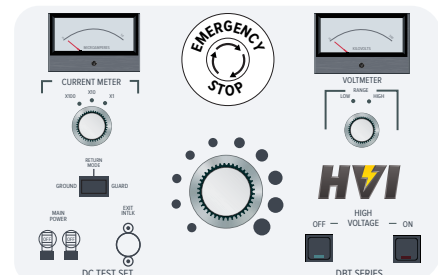

## Optional Accessories



### Hand and Foot Safety Interlock Switches

Dead man style safety switches that connect to the external interlock provisions on the rear terminal block of the HPA DC Dielectric Test set the switch must be depressed before "HV On" and remain depressed during the duration of the testing. Releasing the switch has the same effect as hitting "HV Off", turning off the high voltage circuit. Supplied with 12 foot lead.

### Grounding Sticks

Safely confirm the device under test has been discharge and is at ground potential before handling after testing.

### Reusable Shipping Cases

Reusable hard shipping cases designed for safe transportation of your DBT Series DC Hipot.

## Optional Upgrades



### Digital Metering

Add 3.5-digit digital meters to models with analog meters as standard equipment. Deletes any volt or current meter range switches.

## Matrix of Models/Specs



DBT-15



DBT-37.5

### DBT-15

**Input:** 120Vac, 60Hz, 10A (DBT-15)  
230Vac, 50Hz, 5A (DBT-15F5)  
230Vac, 60Hz, 5A (DBT-15F6)  
+/-1% input voltage regulator

**Output:** 0 – 15 kV DC @ 10 mA, negative polarity,  
positive ground  
Full Wave Bridge Rectification

**Duty:** Continuous, capacitive charging

**Voltmeter:** 3.5", scaled 0 – 7.5/15 kV DC,  $\pm 2\%$  F.S.

**Current Meter:** 3.5", scaled 0 – 1.0  $\mu$ Adc,  $\pm 2\%$  F.S. with  
multipliers of x 1, x 10, x 100, x 1 k, x 10 k.  
Guard/ground load return

**Megohmmeter:** Scaled 100 -1 M $\Omega$   $\pm 2\%$  F.S. with multipliers  
of x 0.1, x 1, x 10, x 100, x 1 k

**Size & Weight:** 4 x 11 x 14 in., 55 lbs.  
356 x 279 x 356 mm, 25 kg

**Output Termination:** 20 ft. (6 m) shielded output cable  
with alligator clamp

**Scope of Supply:** 20ft red test lead, 20ft black test leads, 10in safety  
ground stick, external interlock plug, operations manual,  
calibration certificate

### DBT-37.5

120Vac, 60Hz, 10A (DBT-37.5)  
230Vac, 50/60 Hz, 5A (DBT-37.5F5)  
230Vac, 60Hz, 5A (DBT-37.5F5)  
+/-1% input voltage regulator

0 – 37.5 kV DC @ 10 mA, negative polarity,  
positive ground  
Full Wave Bridge Rectification

Continuous, capacitive charging

3.5", scaled 0 – 15/37.5 kV DC,  $\pm 2\%$  F.S.

3.5", scaled 0 – 1.0  $\mu$ Adc,  $\pm 2\%$  F.S. with  
multipliers of x 1, x 10, x 100, x 1 k, x 10 k.  
Guard/ground load return

Scaled 100 -1 M $\Omega$   $\pm 2\%$  F.S. with multipliers  
of x 0.1, x 1, x 10, x 100, x 1 k

19 x 14 x 13in., 48lbs.  
483 x 356 x 330 mm, 21.7 kg

20 ft. (6 m) shielded output cable  
with alligator clamp

20ft red test lead, 20ft black test leads, 10in safety  
ground stick, external interlock plug, operations manual,  
calibration certificate



**DBT-75**



**DBT-80**

## DBT-75

**Input:** 120Vac, 60Hz, 10A (DBT-75)  
 230Vac, 50Hz, 5A (DBT-75F5)  
 230Vac, 60Hz, 5A (DBT-75F6)  
 +/-1% input voltage regulator

**Output:** 0 – 75 kV DC @ 10 mA, negative polarity,  
 positive ground  
 Full Wave Bridge Rectification

**Duty:** Continuous, capacitive charging

**Voltmeter:** 3.5", scaled 0 – 37.5/75 kV DC, ±2% F.S.

**Current Meter:** 3.5", scaled 0 – 1.0  $\mu$ Adc, ±2% F.S. with  
 multipliers of x 1, x 10, x 100, x 1 k, x 10 k.  
 Guard/ground load return

**Megohmmeter:** Scaled 100 -1 M $\Omega$  ±2% F.S. with multipliers  
 of x 0.1, x 1, x 10, x 100, x 1 k

**Size & Weight:** 19 x 14 x 13in., 66lbs.  
 483 x 356 x 330 mm, 30 kg

**Output Termination:** 20 ft. (6 m) shielded output cable with alligator clamp

**Scope of Supply:** 20ft red test lead, 20ft black test leads, 10in safety  
 ground stick, external interlock plug, operations manual,  
 calibration certificate

## DBT-80

120Vac, 60Hz, 10A, (DBT-80)  
 230Vac, 50/60Hz, 5A (DBT-80F)

0 – 80 kV DC @ 10 mA, negative polarity,  
 positive ground  
 Full Wave Bridge Rectification

Continuous, capacitive charging

3.5", scaled 0 – 40/80 kV DC, ±2% F.S.

3.5", scaled 0 – 1.0  $\mu$ Adc, ±2% F.S. with  
 multipliers of x 1, x 10, x 100, x 1 k, x 10 k.  
 Guard/ground load return

Scaled 100 -1 M $\Omega$  ±2% F.S. with multipliers  
 of x 0.1, x 1, x 10, x 100, x 1 k

21 x 16 x 15in., 70lbs.  
 533 x 406 x 381 mm, 32 kg

20 ft. (6 m) shielded output cable with alligator clamp

20ft red test lead, 20ft black test leads, 10in safety  
 ground stick, external interlock plug, operations manual,  
 calibration certificate

## Matrix of Models/Specs



DBT-100



DBT-130

### DBT-100

**Input:** 120Vac, 60Hz, 15A (DBT-100)  
230Vac, 50/60Hz, 8A (DBT-100F)

**Output:** 0 – 100 kV DC @ 10 mA, negative polarity,  
positive ground  
Full Wave Bridge Rectification

**Duty:** Continuous, capacitive charging

**Voltmeter:** 3.5", scaled 0 – 50/100 kV DC,  $\pm 2\%$  F.S.

**Current Meter:** 3.5", scaled 0 – 1.0  $\mu$ Adc,  $\pm 2\%$  F.S. with  
multipliers of x 1, x 10, x 100, x 1 k, x 10 k.  
Guard/ground load return

**Megohmmeter:** Scaled 100 -1 M $\Omega$  with multipliers  
of x 0.1, x 1, x 10, x 100, x 1 k

**Size & Weight:** Case: 21 x 16 x 15in., 55lbs.  
533 x 406 x 381 mm, 25 kg  
HV Tank: 13 x 14 x 16in., 68lbs.  
330 x 356 x 406 mm, 31 kg

**Output Termination:** 20 ft. (6 m) shielded EPR output cable with alligator  
clamp EPR cable stays flexible in cold weather

**Scope of Supply:** 20ft EPR shielded output cable, 20ft red test lead,  
x2 20ft black test leads, 14in safety ground stick,  
external interlock plug, operations manual,  
calibration certificate

### DBT-130

120Vac, 50/60Hz, 15A (DBT-130)  
230Vac, 50/60Hz, 8A (DBT-130F)

0 – 130 kV DC @ 10 mA, negative polarity,  
positive ground  
Full Wave Bridge Rectification

Continuous, capacitive charging

3.5", scaled 0 – 75/150 kV DC,  $\pm 2\%$  F.S.

3.5", scaled 0 – 1.0  $\mu$ Adc,  $\pm 2\%$  F.S. with  
multipliers of x 1, x 10, x 100, x 1 k, x 10 k.  
Guard/ground load return

Scaled 100 -1 M $\Omega$   $\pm 2\%$  F.S. with multipliers  
of x 0.1, x 1, x 10, x 100, x 1 k

Case: 21 x 16 x 15in., 55lbs.  
533 x 406 x 381 mm, 25 kg  
HV Tank: 13 x 12 x 18in., 87lbs.  
330 x 305 x 457 mm, 39 kg

20ft. (6m) shielded EPR output cable with alligator  
clamp EPR cable stays flexible in cold weather

0ft EPR shielded output cable, 20ft red test lead,  
x2 20ft black test leads, 14in safety ground stick,  
external interlock plug, operations manual,  
calibration certificate



**DBT-200**



**DBT-300**

## DBT-200

**Input:** 120Vac, 50/60Hz, 15A (DBT-200)  
230Vac, 50/60Hz, 8A (DBT-200F)

**Output:** 0 – 200 kV DC @ 5 mA, negative polarity,  
positive ground  
Full Wave Bridge Rectification

**Duty:** Continuous, capacitive charging

**Voltmeter:** 3.5", scaled 0 – 80/200 kV DC,  $\pm 2\%$  F.S.

**Current Meter:** 3.5", scaled 0 – 1.0  $\mu$ Adc,  $\pm 2\%$  F.S. with  
multipliers of x 1, x 10, x 100, x 1 k, x 10 k.  
Guard/ground load return

**Megohmmeter:** Scaled 100 -1 M $\Omega$   $\pm 2\%$  F.S. with  
multipliers of x 0.1, x 1, x 10, x 100, x 1 k

**Size & Weight:** Case: 21 x 16 x 15in., 55lbs.  
533 x 406 x 381 mm, 25 kg  
HV Tank: 13 x 14 x 28in., 150lbs.  
330 x 356 x 711 mm, 68 kg

**Output Termination:** 20 ft. (6m) shielded EPR output cable with alligator  
clamp EPR cable stays flexible in cold weather

**Scope of Supply:** 20ft EPR shielded output cable, 20ft red test lead, x2  
20ft black test leads, 14in safety ground stick, external  
interlock plug, operations manual, calibration certificate

## DBT-300

120Vac, 50/60Hz, 15A (DBT-300)  
230Vac, 50/60Hz, 8A (DBT-300F)

0 – 300 kV DC @ 5 mA, negative polarity,  
positive ground  
Full Wave Bridge Rectification

Continuous, capacitive charging

3.5", scaled 0 – 120/300 kV DC,  $\pm 2\%$  F.S.

3.5", scaled 0 – 1.0  $\mu$ Adc,  $\pm 2\%$  F.S. with  
multipliers of x 1, x 10, x 100, x 1 k, x 10 k.  
Guard/ground load return

Scaled 100 -1 M $\Omega$   $\pm 2\%$  F.S. with  
multipliers of x 0.1, x 1, x 10, x 100, x 1 k

Case: 14 x 11 x 14 in., 34 lb.  
356 x 279 x 356 mm, 15 kg  
HV Tank: 36 x 36 x 43.5 in., 380 lb.  
915 x 915 x 1105 mm, 172 kg

Top toroid

20ft red test lead, x2 20ft black test leads, x2 20kohm  
external limit resistors, 14in safety ground stick, external  
interlock plug, operations manual, calibration certificate

## Matrix of Models/Specs



PTS-600BT

### PTS-600BT

**Input:** 120Vac, 50/60Hz, 30A (PTS-600BT)  
230Vac, 50/60Hz, 15A (PTS-600BT)

**Output:** 0 – 600 kV DC @ 5 mA Bench top controller, negative polarity, positive ground, Full Wave Bridge Rectification

**Duty:** Continuous, capacitive charging

**Voltmeter:** 3.5", scaled 0-300/600 kV DC  $\pm 2\%$  F.S.

**Current Meter:** 3.5", scaled 0-1.0  $\mu$ A DC,  $\pm 2\%$  F.S. with multipliers of x 1, x 10, x 100, x 1 k, x 10 k  
Guard/ground load return

**Megohmmeter:** 100 – 1 M $\Omega$  w/x.1, x1, x10, x100, x1k ranges, w/analog meters

**Size & Weight:** Case: 21 x 15.5 x 15 in., 70 lb.  
535 x 395 x 382 mm, 32 kg  
HV Tank: 36 x 15 x 89 in., 580 lb.  
914 x 381 x 1105 mm, 263 kg

**Output Termination:** Top toroid

**Scope of Supply:** 20ft red test lead, x2 20ft black test leads, x4 20kohm external limit resistors, 14in safety ground stick, external interlock plug, operations manual, calibration certificate





# DTS SERIES CONTENTS

- Oil Dielectric Test Sets for Field, Shop, and Factory Use ..... 100
- Test Cells/Oil Vessels ..... 101
- Controls and Configurations ..... 102
- Optional Accessories ..... 102
- DTS Series Specifications ..... 103

# OIL DIELECTRIC TEST SETS FOR FIELD, SHOP, AND FACTORY USE

The DTS D Series are 0-60 kVac and 0-100 kVac CE Marked liquid dielectric test sets. They are typically used for testing the breakdown voltage level of insulating oils, hydraulic oils, and other dielectric fluids per the most common world standards including ASTM D877, ASTM D1816, and IEC 156. There are three user-selectable automatic voltage rates-of-rise when the sample breaks down, the voltage level is displayed on the memory volt meter until the next test is run. Its durable aluminum construction, small footprint, removable oil drip tray, and rugged design make our DTS series ideal for field, factory, or laboratory use.



DTS-60D



DTS-100D

The DTS A Series are 0-60 kVac and 0-100 kVac fully automatic liquid dielectric test sets, typically used for testing the breakdown voltage level of insulating oils, hydraulic oils, and other dielectric fluids. The most common world standards including ASTM D877, ASTM D1816, and IEC 156 are preprogrammed into the controls for easy operation. Just hit the start button and the test is performed. Custom test sequences may also be programmed. Test results are stored internally and can be downloaded to a computer via RS232 or printed using the onboard thermal printer. Convenience features like a removable oil drip tray, removable test cell storage tray and rugged design make our DTS series ideal for field, factory, or laboratory use.



DTS-60A



DTS-100A

## Test Cells/Oil Vessels

High Voltage, Inc. offers 60kV and 100kV test cells capable of testing to ASTM D877 and D1816 and IEC 156 standards as well as many local standards such as UTE C27-221/74, CEI 10-1/73, VDE 370, IRAM 2341/72, RVHP 1985, and PN-77/ED4408.

### 60kV Test Cells

- **TCD-3** For ASTM D877, flat disc electrodes, 150mL sample size, 0.100-inch gap adjustment gauge
- **TCD-5** For ASTM D1816, spherical electrodes, 625mL sample size, 0.100, 0.080, and 0.040-inch gap adjustment gauges, includes motorized stirring assembly
- **TCD-12** For IEC 156, spherical electrodes, 625mL sample size, 0.100-inch gap adjustment gauges

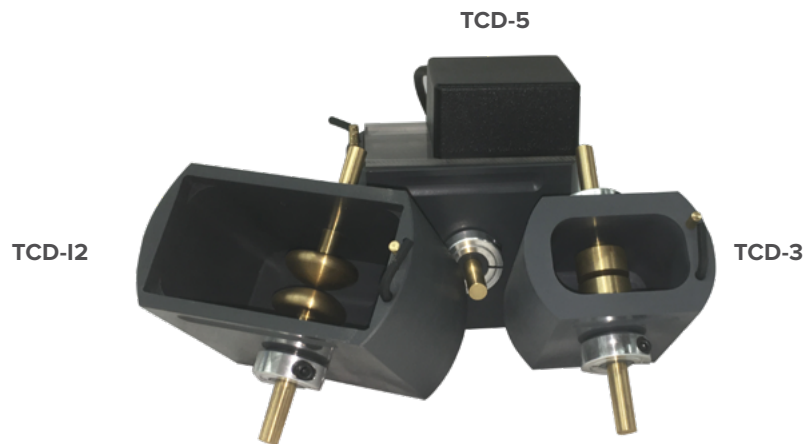

### 100kV Test Cells

- **TCD-N3** For ASTM D877, flat disc electrodes, 625mL sample size, 0.100-inch gap adjustment gauge
- **TCD-N5** For ASTM D1816, spherical electrodes, 625mL sample size, 0.100, 0.080, and 0.040-inch gap adjustment gauges, includes motorized stirring assembly
- **TCD-N12** For IEC 156, spherical electrodes, 625mL sample size, 0.100-inch gap adjustment gauges



## Controls and Configuration

### DTS-60D and DTS-100D

- Three motorized rates of rise: 500V/2000V/3000V per second
- Arc detection with automatic shutdown and failure indicator
- Failure indication with memory volt meter
- Window panel for test observation
- Convenient removable tray for test cell storage
- Convenient removable drip tray in bottom of test chamber
- Accessory outlet located within test chamber
- One-piece portable design
- Zero Start safety and test chamber interlock provision

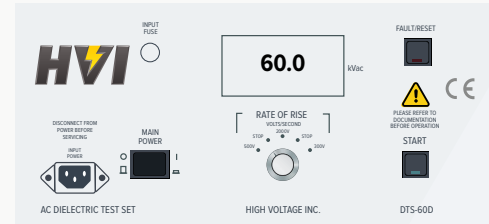

### DTS-60A and DTS-100A

- Clear and easy to use controls
- 128 x 64 dot matrix crystal display
- “12 preprogrammed standard test sequences;
  - ASTM D1816/12, ASTM D877/13, IEC 156/95, IEC 156/63, ASTM D1816/84, ASTM D877/87, UTE C27-221/74, CEI 10-1/73, VDE 370, IRAM 2341/72, RVHP 1985, and PN-77/ED4408
- Internal memory holds last 50 tests w/ RS232 interface
- User definable test sequences
- Ambient temperature sensor
- English, German, Spanish, French, Greek
- Thermal printer included

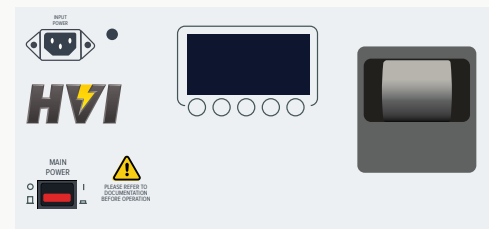

## Optional Accessories

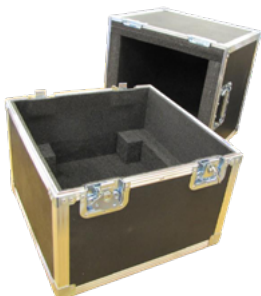

### Reusable Shipping Cases

Reusable hard shipping cases designed for safe transportation of your DTS Series Oil/Liquid Dielectric Test Set.

- DTS-60D / DTS60A | part #32-0393
- DTS-100D / DTS100A | part #32-0391

## DTS Series Specifications



**DTS-60D**



**DTS-100D**

### DTS-60D

**Input:** 120 V, 60 Hz, 7 A (DTS-60D)  
230 V, 50/60hz, 3 A (DTS-60DF)

**Output:** 0-60 kVac, 800 VA resistive load

**Meter Accuracy:** +/- 2% of full scale

**Optional Test Cells:** TCD-3 for ASTM D877, TCD-5 for ASTM  
(Sold Separately) D1816, TCD-I2 for IEC 156

**Operating Temperature:** 14° to 104° F, -10° to 40° C

**Size & Weight:** 14.75 x 14 x 11.5 in., 60lb  
375 x 356 x 291 mm, 27kG

**Output Termination:** Dual capacitive graded bushings in test chamber

### DTS-100D

120 V, 60 Hz, 7 A (DTS-100D)  
230 V, 50/60hz, 3 A (DTS-100DF)

0-100 kVac, 800 VA resistive load

+/- 2% of full scale

TCD-N3 for ASTM D877, TCD-N5 for ASTM  
D1816, TCD-NI2 for IEC 156

14° to 104° F, -10° to 40° C

18.5 x 16.5 x 16.5 in., 100lb  
470 x 419 x 419 mm, 45kG

Dual capacitive graded bushings in test chamber



**DTS-60A**



**DTS-100A**

## DTS-60A

**Input:** 120 V, 60 Hz, 7 A (DTS-60A)  
230 V, 50/60hz, 3 A (DTS-60AF)

**Output:** 0-60 kVac, 800 VA resistive load

**Optional Test Cells:** TCD-3 for ASTM D877, TCD-5 for ASTM D1816, TCD-I2 for IEC 156  
*(Sold Separately)*

**Controls:** 12 pre-programmed test sequences / User programmable test routines. 128 x 64 dot matrix crystal display / Intuitive, easy to use controls in English, German, Spanish, French, Greek / Thermal printer

**Size & Weight:** 14.75 x 14 x 11.5 in., 60lb  
375 x 356 x 291 mm, 27kG

**Output Termination:** Dual capacitive graded bushings in test chamber

## DTS-100A

120 V, 60 Hz, 7 A (DTS-100A)  
230 V, 50/60hz, 3 A (DTS-100AF)

0-100 kVac, 800 VA resistive load

TCD-N3 for ASTM D877, TCD-N5 for ASTM D1816, TCD-NI2 for IEC 156

10 pre-programmed test sequences / User programmable test routines. 128 x 64 dot matrix crystal display / Intuitive, easy to use controls in English, German, Spanish, French, Greek / Thermal printer

18.5 x 16.5 x 16.5 in., 100lb  
470 x 419 x 419 mm, 45kG

Dual capacitive graded bushings in test chamber

# CDS SERIES CONTENTS

HVI - The Cable Testing & Fault Locating Equipment Company .....	106
A Controlled Energy Thumper With Burn Capability is a Necessity .....	107
CDS-2010U / CDS-2010UF .....	108
CDS-3616U / CDS-3616UF / CDS-3632U / CDS-3632UF .....	109
VT33 / VT33F .....	110

## Options Available:

- Safety ground sticks (10 inch & 14 inch)
- Hand Safety Interlock Switch
- Foot Safety Interlock Switch
- Cable reels (100 feet to 330 feet)
- MC Output Adapters
- Time Domain Reflectometer/Cable Radar
- Acoustical/Magnetic Listening Devices
- SKD Series - Custom Fault Locating Skid Packages



# HVI – THE CABLE TESTING & FAULT LOCATING EQUIPMENT

**HVI has extensive knowledge** and field experience in fault locating and cable testing along with the best tools for the job. Fault locating requires more than just a thumper. Efficient fault locating requires the convergence of knowledge, methodology, and the right hardware. A total approach is needed to get the job done quickly to minimize customer outage time and prevent further damage to the cable system. This includes knowledge of the cable systems design, construction, history, accurate maps, proper fault locating procedures and the right thumper which should include a high resistance fault burn down method, time domain reflectometer/cable radar compatibility, and a top level acoustic/electromagnetic listening device. HVI can assemble the best system and approach possible to meet all needs from 5kV – 230kV cable.

## Q. Why Choose HVI Thumpers?

### A. HVI Thumpers Offer All the Features Needed

When fault locating, remember this: do no harm. Don't harm your insulation and accessories by thumping your 15kV cable at 25kV for hours looking for a fault. Use proper methods and technologies. The goal should be to thump at the lowest possible voltage yet deliver the highest possible energy to find the fault. Locate the fault without making more. To do this you need a thumper with a variable hipot output, multiple full energy discharge outputs, and ample burn current to condition a fault to arc at a lower voltage. HVI thumpers offer all the features and power necessary. Don't handicap your fault locating efforts by spending the same or more for inferior equipment. HVI thumpers provide all the tools you need.

- **Fully Variable Hipot Output On All Three Voltage Settings** Needed to identify faulted cable, show breakdown voltage to help choose tap, burn fault and hipot cables after repair.
- **Highest Burn Current** Burns down high resistance faults to permit thumping at lower, less damaging voltage levels. This standard feature on all HVI thumpers may not even be an option from other manufacturers.
- **Three Output Voltage Taps All At Full Energy** Allows thumping at lower voltages. Noise of maximum joules @ 5kV = noise of maximum joules @ 20kV.
- **Variable Discharge Rate** 6 – 10 second discharge/thump rate. Faster and slower discharge rates are not advisable.
- **TDR/Radar Ready** Use your old TDR or buy a new one. A separate TDR is advantageous over an integrated TDR. This setup offers greater flexibility allowing use without the thumper in the field, downloading the saved waveforms, or for training purposes. This also allows for plug and play connections when its time to upgrade to the newest technologies.
- **Battery Operation** HVI thumpers are not battery operated. Thumpers of this class that are battery operated must sacrifice other necessary features like variable hipot outputs and burning capabilities, missing half of what a thumper should be. In addition, some have as long as 15 seconds between discharges, greatly slowing the fault location process. Also, battery life is short, assuming that you remembered to keep it charged between uses. Battery operation is not worth the sacrifice.

## A Controlled Energy Thumper With Burn Capability is a Necessity

Due to the known problems associated with DC cable testing, most utilities worldwide have abandoned DC testing of solid dielectric cable (many have switched to VLF AC testing), or greatly reduced their test voltage levels, yet they then thump cables at voltages of 2 – 3 times normal line to-ground voltage. They find the fault but make more in the process. This is avoided by using HVI thumpers with three output voltage taps, and high burn currents used to reduce fault impedances to permit lower voltage thumping. HVI thumpers can thump at voltages below normal line-to-ground voltage yet still deliver maximum joule energy, thereby minimizing damage to the cable system and still supplying the required noise for rapid location.

$$\text{Energy} = \text{Watt Seconds} = \text{Joules} = 1/2 CV^2 = \text{Fault Arc Intensity} = \text{Noise} = \text{Electro-Magnetic Discharge}$$

**PROBLEM:** To deliver the full joules of energy possible to a fault, the capacitors within a thumper must be charged to the maximum voltage. With the wrong thumper, this often results in thumping a cable at an excessive voltage, causing significant damage to insulation and accessories. Since the applied voltage is a square function ( $1/2 CV^2$ ), if the thumper is at  $2/3$  voltage, only 45% of the joules are delivered to the fault. At half voltage only 25% energy is delivered, making the fault hard to hear. Either fault locating takes far longer than necessary or the crew gets impatient and turns the voltage all the way up to get the loudest bang. The fault is found but other benign issues within the cable system are transitioned into growing electrical trees which will be your next in service failure. This practice can and should be avoided.

**SOLUTION:** Use a multi-tapped, “controlled energy” thumper like those from HVI. With three output voltage taps and ample burn current to condition faults, fault location can be performed at voltages far lower than before. Find your fault quickly while avoiding damage. Wouldn't you rather thump at 5kV instead of 20kV, as long as the discharge energy, or noise, was equal? The measure of a good thumper is not the maximum voltage it can discharge, but the minimum voltage still capable of delivering the full energy. For instance, our 5/10/20 kV output model is a far better choice than the 12.5/25kV model from others.

## Model CDS-2010U / CDS-2010UF

### Cable Fault Locators

The High Voltage Inc **CDS-2010U / CDS-2010UF** are designed for fault location on cable systems rated up to 35kV, where the line to neutral voltage is approximately 20kv. With 1000 joules available at 5/10/20 kV, the CDS-2010U / CDS-2010UF offers a powerful impulse ideal for using acoustic and electro-magnetic detection instruments and is a true controlled/constant energy thumper. Equipped with a built in high voltage coupler, the CDS-2010U / CDS-2010UF are TDR/cable radar ready for arc reflection and current impulse methods. With up to 400 mA of burn current, high resistance faults can be rapidly reduced permitting fault location at less damaging voltage levels. Find your fault without causing the next one!

There are no better thumpers. The CDS-2010F / CDS-2010UF offers best in class features: Full impulse energy at 5/10/20kV, variable hipot/burn in all 3 taps (400 mA @ 5 kV tap, 200 mA @ 10 kV tap, 100 mA @ 20 kV tap), EPR high voltage output cable that stays flexible even in cold weather, TDR/Radar ready, and extremely durable and portable design with small footprint for years of reliable operation. Available in 120 Vac, 20 A input and 230 Vac, 15 A input (F suffix).



**Input:** 120Vac, 60Hz, 25A (CDS-2010U)  
230Vac, 50/60Hz, 15A (CDS-2010UF)

**Hipot Output:** 0 - 5/10/20kVdc

**Hipot Burn Current:** 400/200/100mA

**Discharge Output:** 1000 Joules at max voltage in each tap

**Discharge Rate:** 6-10 seconds

**TDR Interface:** Arc Reflection  
Current Pulse

**Size:** 27in w x 27in d x 48in h  
686mm w x 686mm d x 1219mm h

**Weight:** 260lb  
118kg

**Output Termination:** 50ft HV, Return, and Ground

**Optional Cable Reels:** 100 to 330ft of HV, Return and Ground on Reels

**Other Features:** Rugged Transit Protected Meters  
External Interlock  
Emergency Off Mushroom Switch  
Internal Heater to limit condensation  
Integrated Coupler/Filter/TDR Interface for:  
Arc Reflection Method  
Current Impulse Method

**Optional Upgrade** 3 Range Current Meter



**Compare the CDS Series  
on pages 7-8**

**The Network Systems Thumper**

The High Voltage Inc **CDS-36** series of primary cable fault locators are ideal for Network Systems or other situations involving cables rated up to 69kV, oil insulated cables, and/or long cable lengths. Available with either 1600 or 3200 joules, the CDS-36 series offers a powerful impulse ideal for using acoustic and electro-magnetic detection instruments. The CDS-3616U / CDS-3616UF offers 1600 Joules at 9/18/36 kV while the CDS-3632U / CDS-3632UF offers 3200 Joules at 9/18/36kV, true controlled/constant energy thumpers. Equipped with a built in high voltage coupler, the CDS-36 series are TDR/cable radar ready for arc reflection and current impulse methods. With up to 280 mA of burn current, high resistance faults can be rapidly reduced permitting fault location at less damaging voltage levels. Find your fault without causing the next one! There are no better thumpers.



**Thumper Specification Review**

Don't handicap your fault finding efforts by buying a thumper with only half the features necessary. For the same money, you can buy a full featured thumper. When specifying, require:

- At least two full joule output voltage settings, preferably three, with at least 1000 joules of energy
- A variable hipot output with high burn current of at least 200mA
- Variable discharge rate from 6 – 10 seconds
- A remote TDR/radar, not one built-in, for flexibility, versatility, ease in service, and ease in use

- Input:** 120Vac, 60Hz, 25A  
(CDS-3616U, CDS-3632U)  
230Vac, 50/60Hz, 15A  
(CDS-3616UF, CDS-3632UF)
- Hipot Output:** 0 - 9/18/36kVdc
- Hipot Burn Current:** 280/140/70mA
- Discharge Output:** 1600 Joules at max voltage in each tap  
(CDS-3616U)  
3200 Joules at max voltage in each tap  
(CDS-3632U)
- Discharge Rate:** 6-10 seconds
- TDR Interface:** Arc Reflection  
Current Pulse
- Size:** 25in w x 29in d x 44.5in h  
(30"w with attached cable reel)  
635mm w x 737mm d x 1130mm h
- Weight:** 375lb/170kg (CDS-3616U, CDS-3616UF)  
450lb/204kg (CDS-3632U, CDS-3632UF)
- Output Termination:** 100ft HV, Return, and Ground
- Optional Cable Reels:** 100 to 300ft HV, Return, and Ground on Reels
- Other Features:** Rugged Transit Protected Meters  
External Interlock  
Emergency Off Mushroom Switch  
Window to view Groundig Solenoid  
Internal Heater to limit condensation  
Integrated Coupler/Filter/TDR Interface for:  
Arc Reflection Method  
Current Impulse Method
- Optional Upgrade** 3 Range Current Meter

**Compare the CDS Series  
on pages 7-8**

## Model VT33 / VT33F

### VLF Thumper Combination

With cable diagnostic testing becoming more common, the need for cable fault location will rise. If you're in the market for a thumper, why not get one with a VLF hipot built-in to test the AC integrity of the cable following repair. The **VT33 / VT33F** is our lightest portable primary cable fault locator and the only one with an included ac VLF hipot. Designed for cables rated up to 25 kV, it incorporates both a 0 to 13 kV, up to 760 joule thumper and a 0 to 33 kV ac, 0.1Hz VLF hipot capable of testing a 1 uF load, approximately 10,000 feet of shielded power cable. The VLF hipot is also designed to burn the fault, quickly reducing the resistance of the fault, lowering the breakdown voltage. Thumping at lower voltages reduces the risk of creating more faults. The VT33 produces a discharge every 8 seconds for pinpointing the fault with an acoustic / magnetic detector. Like all HVI cable fault locators, The **VT33 / VT33F** is TDR-ready and works with most popular brands of Time Domain Reflectometer also known as "cable radar".



**Input:** 120Vac, 60Hz, 10A (VT33)  
230Vac, 50/60Hz, 5A (VT33F)

**Hipot Output:** 0-33kVac peak @ 0.1Hz, 1uF max load

**Hipot Burn Current:** VLF Burner - Arcs cable every few seconds

**Discharge Output:** 760 Joules at 13kVdc

**Discharge Rate:** 8 seconds fixed

**TDR Interface:** Arc Reflection

**Size:** 28in w x 26in d x 44in h  
711mm w x 660mm d x 1118mm h

**Weight:** 245lb  
111kg

**Output Termination:** 50ft HV, Return, and Ground

**Optional Cable Reels:** 100 to 330ft HV, Return, and Ground on Reels

**Other Features:** Rugged Transit Protected Meters  
External Interlock  
Emergency Off Mushroom Switch  
Window to view Grounding Solenoid  
Internal Heater to limit condensation  
Integrated Coupler/Filter/TDR Interface for:  
Arc Reflection Method  
Current Impulse Method



Compare the CDS Series  
on pages 7-8



## Compare CDS Series



CDS-2010U



CDS-3616U

### CDS-2010U

**Input:** 120Vac, 60Hz, 25A (CDS-2010U)  
230Vac, 50/60Hz, 15A (CDS-2010UF)

**Hipot Output:** 0 - 5/10/20kVdc

**Hipot Burn Current:** 400/200/100mA

**Discharge Output:** 1000 Joules at max voltage in each tap

**Discharge Rate:** 6-10 seconds

**TDR Interface:** Arc Reflection  
Current Impulse

**Size:** 27in w x 27in d x 48in h  
686mm w x 686mm d x 1219mm h

**Weight:** 260lb / 118kg

**Output Termination:** 50ft HV, Return, and Ground

**Optional Cable Reels:** 100 - 330 ft HV, Return, and Ground on Reels

**Other Features:** Rugged Transit Protected Meters  
External Interlock  
Emergency Off Mushroom Switch  
Internal Heater to limit condensation  
Integrated Coupler/Filter/TDR Interface for:  
Arc Reflection Method  
Current Impulse Method

**Optional Upgrade:** 3 Range Current Meter

### CDS-3616U

**Input:** 120Vac, 60Hz, 25A (CDS-3616U)  
230Vac, 50/60Hz, 15A (CDS-3616UF)

**Hipot Output:** 0 - 9/18/36kVdc

**Hipot Burn Current:** 280/140/70mA

**Discharge Output:** 1600 Joules at max voltage in each tap

**Discharge Rate:** 6-10 seconds

**TDR Interface:** Arc Reflection  
Current Impulse

**Size:** 25in w x 29in d x 44.5in h  
(30" w with attached cable reel)  
635mm w x 737mm d x 1130mm h

**Weight:** 375lb / 170kg

**Output Termination:** 100ft HV, Return, and Ground

**Optional Cable Reels:** 100 - 300 ft HV, Return, and Ground on Reels

**Other Features:** Rugged Transit Protected Meters  
External Interlock  
Emergency Off Mushroom Switch  
Window to view Grounding Solenoid  
Internal Heater to limit condensation  
Integrated Coupler/Filter/TDR Interface for:  
Arc Reflection Method  
Current Impulse Method

**Optional Upgrade:** 3 Range Current Meter



**CDS-3632U**



**VT33**

## CDS-3632U

## VT33

**Input:** 120Vac, 60Hz, 25A (CDS-3632U)  
230Vac, 50/60Hz, 15A (CDS-3632UF)

120Vac, 60Hz, 10A (VT33)  
230Vac, 50/60Hz, 5A (VT33F)

**Hipot Output:** 0 - 9/18/36kVdc

0-33kVac peak @ 0.1Hz, 1uF max load

**Hipot Burn Current:** 280/140/70mA

VLF Burner - Arcs cable every few seconds

**Discharge Output:** 3200 Joules at max voltage in each tap

760 Joules at 13kVdc

**Discharge Rate:** 6-10 seconds

8 seconds fixed

**TDR Interface:** Arc Reflection  
Current Impulse

Arc Reflection

**Size:** 25in w x 29in d x 44.5in h  
(30" w with attached cable reel)  
635mm w x 737mm d x 1130mm h

28in w x 26in d x 44in h  
711mm w x 660mm d x 1118mm h

**Weight:** 450lb / 204kg

245lb / 111kg

**Output Termination:** 100ft HV, Return, and Ground

50ft HV, Return, and Ground

**Optional Cable Reels:** 100 - 330 ft HV, Return, and Ground on Reels

100 - 300 ft HV, Return, and Ground on Reels

**Other Features:** Rugged Transit Protected Meters  
External Interlock  
Emergency Off Mushroom Switch  
Window to view Grounding Solenoid  
Internal Heater to limit condensation  
Integrated Coupler/Filter/TDR Interface for:  
Arc Reflection Method  
Current Impulse Method

Rugged Transit Protected Meters  
External Interlock  
Emergency Off Mushroom Switch  
Window to view Grounding Solenoid  
Internal Heater to limit condensation  
Integrated Coupler/Filter/TDR Interface for:  
Arc Reflection Method  
Current Impulse Method

**Optional Upgrade:** 3 Range Current Meter

### Accessories

HVI can provide all the accessories needed to put together a complete fault locating system. Fault locating is an approach, not just a thumper. Don't spend a lot of money on a thumper but not the extra few thousand for a top level listening device to make your efforts more effective. Don't thump for hours wasting time and damaging your cable when a TDR trace can show you the fault location in two minutes, With the right accessories, sectionalizing and pin point location of the fault have never been faster. Consult with HVI on the accessories most appropriate for your situation. We have our favorites but can supply anything needed. For a TDR, nearly any model now available works great.

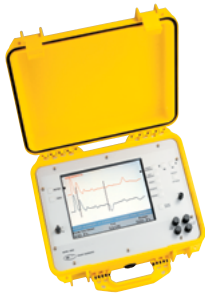

#### **TDR: Time Domain Reflectometer: TDR-1670 and TDR-1670CI from Radar Engineers**

Radar Engineers Model TDR-1670 is a portable Time Domain Reflectometer ("cable radar") from Radar Engineers specially designed for use with thumpers connected to an arc reflection filter for "pre-locating" high resistance (pinhole) faults in buried primary power cables. This product integrates seamlessly with the CDS Series and the VT-33 thumper for pre-locating faults using the arc reflection method. The Model TDR-1670CI offers the Current Impulse method of fault location as well as the standard Arc Reflection method.

The 1670 and 1670CI also locate low resistance faults, splices, and opens on a stand-alone basis. Digital radar captures and holds the fault trace at the instant of the thump. Software then automatically positions a marker at the fault, and the distance to the fault is indicated on the screen. These TDR's are also packaged in a rugged weather resistant plastic case and can be bolted to most hand trucks.



#### **SDAD Super Directional Acoustic Detector from Aquatronics**

The SDAD from Aquatronics is an acoustic and magnetic/ballistic detector used in conjunction with a cable fault locator/thumper to help quickly isolate faults in underground primary cables. The SDAD's main features are direction to fault to help you get to the failure faster, ballistic impulse bar graph to keep you on the cable path, and depth indication after you have located the fault.



#### **X35: Electromagnetic Field Analyzer**

The X35 from Technology Enhancement Corporation is designed to ease the process of fault location on a primary network system. The X35 detects the impulses from a primary cable fault locator/thumper and are displayed on easy to read LCD screen. This allows you to interrogate the faulted network system while remaining above ground and along the cable path, sectionalizing between manholes without opening them.





### Cable Reels CRR-100T

Cable reel with 100 ft (30 meters) of high voltage output cable terminated with an MC connector and 100 ft (30 meters) of ground cable terminated every 10 ft for ground connection. Other lengths available up to 330 ft (100 meters), consult factory or your local sales rep or exclusive sales agency for more information.



### Load Break Elbow LBE-36

Customer supplied load break elbow that is fitted with 12 inches of cable and a female MC connector. Designed for use with our CDS series of thumpers, VLF series of VLF Hipots, and E-Series of VLF Hipots.



### 15/25kV Stinger 88-049

15kV/25kV bushing probe with a female MC connector. Hotsitck compatible. Designed for use with our CDS series of thumpers, VLF series of VLF Hipots, and E-Series of VLF Hipots.



### MC Vice Grip 88-050

Vise grip clamp fitted with a female MC connector. Designed for use with our CDS series of thumpers, VLF series of VLF Hipots, and E-Series of VLF Hipots.



### Hotline Clamp 88-051

Hotline clamp fitted with a female MC connector. Hotsitck compatible. Designed for use with our CDS series of thumpers, VLF series of VLF Hipots, and E-Series of VLF Hipots.



### SKD Series - Custom Fault Locating Skid Packages

HVI can combine all of the cable testing, diagnostic, and fault location equipment you need onto a compact and organized metal skid. Storage slots for your CDS Thumper, Cable Reels, VLF Hipot, Tan Delta Bridge, Partial Discharge Detection Equipment, Time Domain Reflectometer, Listening Device and accessories keep everything secure and organized while in transit and at the jobsite. Our Skid Packages also allow for easy installation into a vehicle, very handy if you do not have a dedicated vehicle for your thumper system. These skid packages are custom fit for your HVI equipment and accessories, designed how and where you need them.



**Ω-CHECK®**  
Concentric Neutral Resistance Tester

**OCK-30**  
**OCK-30F**  
0 - 48V AC, 30A Max

The **Ω-Check®** from HVI is the most accurate, most efficient, and easiest to use method of measuring the integrity of the concentric neutral of a primary power cable while still energized. An intact concentric neutral is essential to your electrical systems reliability and safety and also for ensuring the effectiveness of preventative maintenance testing like VLF withstand, Tan Delta, or Partial Discharge testing, as well as primary cable fault location using Thumpers and TDR. The **Ω-Check®** compares the resistance of the neutral under test to a mathematically perfect neutral of the same specification. Once the operator enters the cable's length, number of neutral strands, and the AWG of the neutral strands, the device applies an AC voltage across the neutral and measures the resultant current. The multiprocessor then calculates the resistance, the ratio of that resistance to that of a perfect neutral of the same design and displays the results in a percentage of the concentric neutral remaining intact and the ratio of the measured resistance to the ideal. Other results displayed are the resistance of the neutral in Ω per 100ft, the voltage & current, and the power factor of the neutral under test. All test data is saved to an SD card for easy storage and transfer to a tablet or laptop.

- Cable remains energized during the test.
- Conforms to IEEE 1617 Standards.
- Helps prevent shock hazards and locate stray voltages/currents.
- Helps overload protection systems function as expected, limiting possible damage.
- Improves the accuracy of Withstand and Diagnostic testing which can be compromised if the neutral is degraded.
- Helps to prioritize cable replacement efforts by comparing the condition of many neutrals.
- Injecting/Rejuvenating cables? Make sure enough neutral remains to justify the time, effort and expense.
- Fault locating cables? Avoid lost time, minimal success, and unsafe conditions if too little neutral remains.

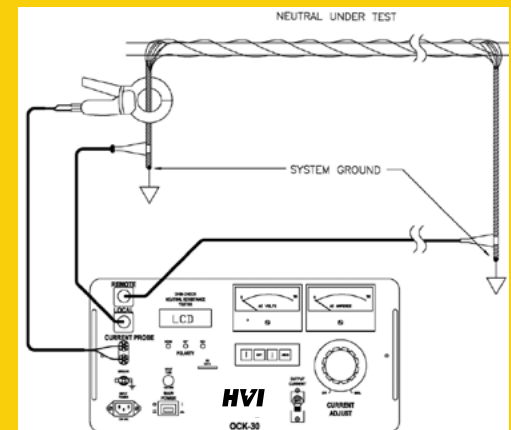

Model	Ω-CHECK® Concentric Neutral Resistance Tester
Input	OCK-30 - 1800VA, 120V@60Hz, 15A max. OCK-30F - 1800VA, 230V@50-60Hz, 8A max.
Output	0-48VAC, 30A max.
Current Probe Input	1000:1, 0-140mA (140ARMS)max
Accuracy (V,I)	±1%
Accuracy (phase)	±1.5°
Temperature (operating)	32 to 113°F, 0 to 45°C
Temperature (storage)	-4 to 158°F, -20 to 70°C
Humidity	0-85% non-condensing
Dimensions	20" x 12" x 19", 508mm x 305mm x 483mm
Weight	OCK-30: 55lb, 25kg OCK-30F: 69lb, 32kg
Scope of Supply	x2 Test Conductor Clamps, x2 500ft Remote Test Lead Reels (1 has connectors at 100ft intervals), 10ft Local Test Lead, Molded Power Cord, 20ft 4AWG Safety Ground Cable, 1000:1 Ratio Current Probe, Users Manual, and Calibration Certificate





**DVR-150 - 1-150 kV AC/DC Divider**  
**DVR-300 - 1-300 kV AC/DC Divider**

The **DVR-150** is HVI's 150 kV precision divider that functions as a probe for your oscilloscope or multimeter. Designed with a precision resistor / capacitor network, it provides a low voltage signal proportional to the applied high voltage. The low-end impedance is switch selectable between 1 MOhm and 10 MOhm, to match your measuring device. Suitable for DC or AC (up to 1 kHz sinusoidal) measurements. Perfect for in-house high voltage calibrations, no external power source required. This divider is not designed for impulse or square wave applications. A reusable shipping case is an available option for the DVR-150.

Model	DVR-150
<b>Voltage Range:</b>	<b>1-150 kV DC or AC to 1 kHz sinusoidal</b>
<b>Output:</b>	1 V per 1 kV applied (1000:1 ratio)
<b>Divider Accuracy:</b>	±0.5%, -14 to 104° F, -10 to 40° C
<b>Input Resistance:</b>	715 MΩ
<b>Input Capacitance:</b>	96.3 pF
<b>Cable Length:</b>	25 ft. (7.6 m) RG 58/U coaxial cable
<b>Divider Termination:</b>	13 in. (330 mm) diameter spinning
<b>Size &amp; Weight:</b> (W x D x H)	13 x 13 x 24.5 in., 20 lb. 330 x 330 x 622 mm, 9 kg

**Optional Accessories**

**Reusable Shipping Case - PN32-066**



The **DVR-300** is HVI's 300 kV precision divider that functions as a probe for your oscilloscope or multimeter. Designed with a precision resistor / capacitor network, it provides a low voltage output signal proportional to the applied high voltage. The low-end impedance is switch selectable between 1 MOhm and 10 MOhm, to match your measuring device. Suitable for DC or AC (up to 1 kHz sinusoidal) measurements. Perfect for in-house high voltage calibrations, no external power source required. This divider is not designed for impulse or square wave applications.

Model	DVR-300
<b>Voltage Range:</b>	<b>1-300 kV DC or AC to 1 kHz sinusoidal</b>
<b>Output:</b>	1 V per 10kV applied (10,000:1 ratio)
<b>Divider Accuracy:</b>	±1.0%, -14 to 104° F, -10 to 40° C
<b>Input Resistance:</b>	1430 MΩ
<b>Input Capacitance:</b>	49.0 pF
<b>Cable Length:</b>	25 ft. (7.6 m) RG 58/U coaxial cable
<b>Divider Termination:</b>	15.75 x 23 in. top pipe toroid spinning
<b>Size &amp; Weight:</b> (W x D x H)	24 x 24 x 61 in., 85 lb. 609 x 609 x 1549 mm, 39 kg

**DVR-150**  
**DVR-300**

Precision Voltage Dividers

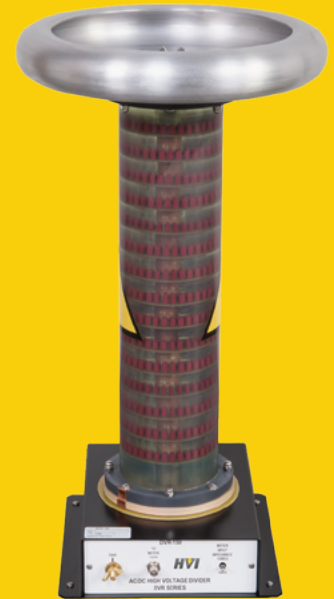







-  [hvinc.com](http://hvinc.com)
-  **31 County Rt. 7A • Copake, NY 12516**
-  **phone: 518.329.3275**
-  **fax: 518.329.3271**
-  **email: [sales@hvinc.com](mailto:sales@hvinc.com)**

© **COPYRIGHT 2023 - HIGH VOLTAGE, INC.** – Manufacturers of high voltage test equipment. Products include portable VLF AC .1Hz to .01Hz. Very Low Frequency, sinewave output hipots up to 200 kV; Tan delta and PD diagnostic measurement bridges for cable diagnostics, portable switchgear and bottle testers up to 100 kV AC ; Portable DC Hipots/Megohmmeters to 300 kV DC ; Oil Test sets at 60 kV or 100 kV; Aerial lift and bucket truck testers to 300 kV AC; High Power AC Dielectric test sets up to 300 kV AC @ 40 KVA; OHM Check concentric neutral tester; Controlled energy cable fault locators, Radar and Tracing devices; 150 kV and 300 kV HV voltage dividers.

Specifications subject to change without notice in the interest of product improvement.